

● **BLAUPUNKT**

Competence Center Car Multimedia
Evo-Sales GmbH
Hastenbecker Weg 33
31785 Hameln/Deutschland
www.blaupunkt.com



⚠ After the manual, if any change, we will not Notice!

● **BLAUPUNKT**

Rearview Camera RVC 2.0

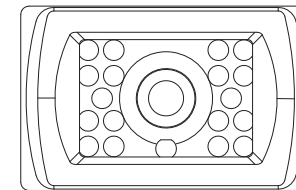

2.009.019.000.000



Product Features:

- High Performance CMOS Sensor
- IR LED Low Light Enhancement
- Waterproof (IP69K)
- Wide View Angle

Camera to bracket hardware

Specifications	Q'ty
 Hex Socket Head M4 X 8L Stainless screws	4
 Flat washer 4.5 X 9.5 X 1mm Stainless	4
 Spring washer 6.6X4.0X1.0mm Stainless	4

Specifications	Q'ty
 Allen	1

Installation

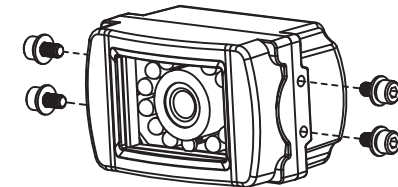

Screw For Use

Hex Socket Head M4 X 8L Stainless screws
Stainless Allen wrench

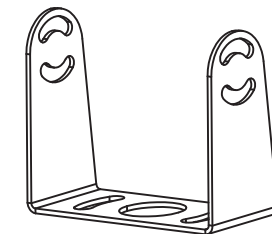

Contents:

- Camera
- Bracket
- Hardware Kit

Installation and Pin Out:

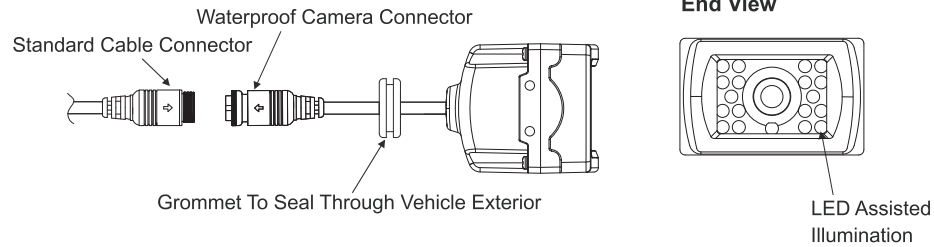

Specifications

Mounting Type	External type
Image sensor	1/4" CMOS camera
Resolution	480 TV lines
Min illumination	1.0 Lux at F2.0 0 Lux with IR on
Water resistance	IP69K
View angle	95(H), 80(V), 120(D)
Dimension	77(W), 44.6(H), 55(D)mm
Working temperature	-20 C ~ +70 C
Weight	Approx. 0.50kg / 0.84lbs

Bracket Mtg. Hole Dimensions

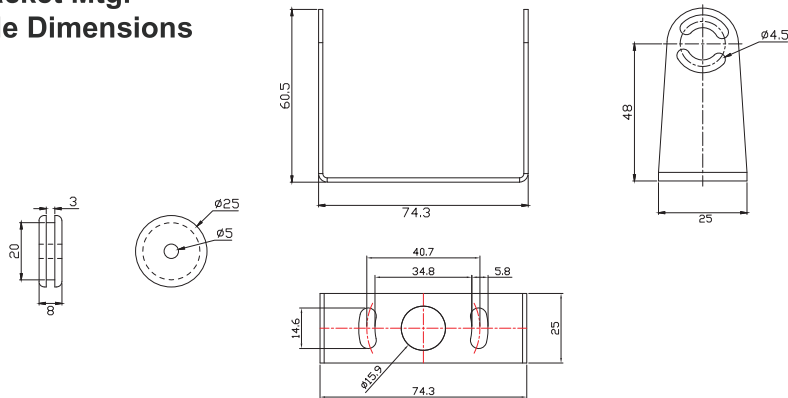

Unit: MM

Recommended grommet Hole

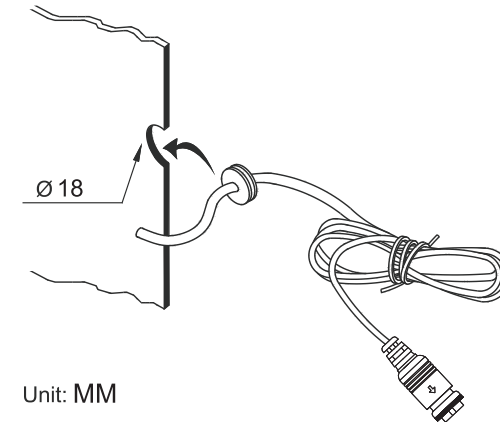

Unit: MM

● **BLAUPUNKT**

Competence Center Car Multimedia
Evo-Sales GmbH
Hastenbecker Weg 33
31785 Hameln/Deutschland
www.blaupunkt.com



⚠ After the manual, if any change, we will not Notice!

● **BLAUPUNKT**

Rückfahrkamera RVC 2.0

2 009 019 000 001

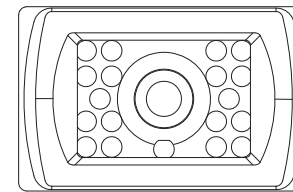





Produkt Features:

- High Performance CMOS Sensor
- IR LED Beamer
- Wasserfest, Schutzklasse IP69K
- Weitwinkel

GERMAN

Kamera zur Hardware-Halterung

Beschreibung	Anzahl
 M4 * 8L Edelstahlschrauben mit Innensechskant	4
 Flache Unterlegscheibe 4,5 * 9,5 * 1 mm rostfrei	4
 Federscheibe 6,6 * 4,0 * 1,0 mm rostfrei	4

Beschreibung	Anzahl
 Inbusschlüssel	1

Einbau

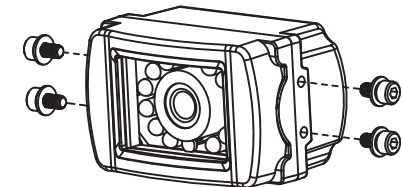

Einsatzschrauben

M4 * 8L Edelstahlschrauben mit
Innensechskant
Edelstahl-Inbusschlüssel

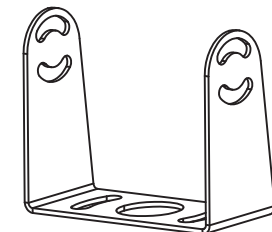

Inhalt:

Kamera
Halterung
Hardware-Kit

Installation und Pin Out:

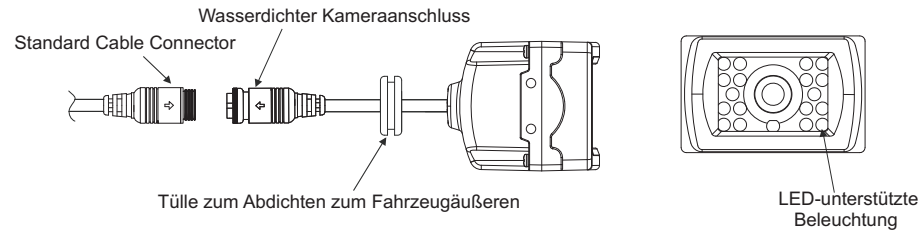

Beschreibung

Befestigungsart	Extern
Bild Sensor	1/4" CMOS Kamera
Resolution	480 TV lines
Min. Beleuchtung	1.0 Lux at F2.0 0 Lux with IR on
Wasserfest	IP69K
Blickwinkel	95(H), 80(V), 120(D)
Abmessungen	77(W), 44.6(H), 55(D)mm
Arbeitstemperatur	-20 C ~ +70 C
Gewicht	Approx. 0.50kg / 0.84lbs

1

6

Halterung Lochabmessungen

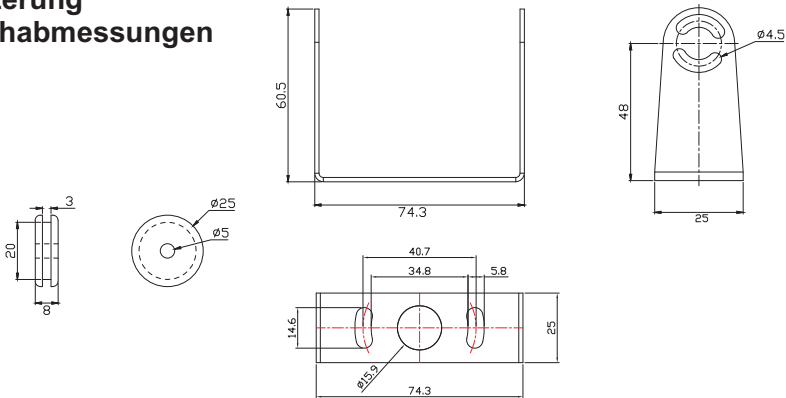

Unit: MM

Empfohlenes Tüllenloch

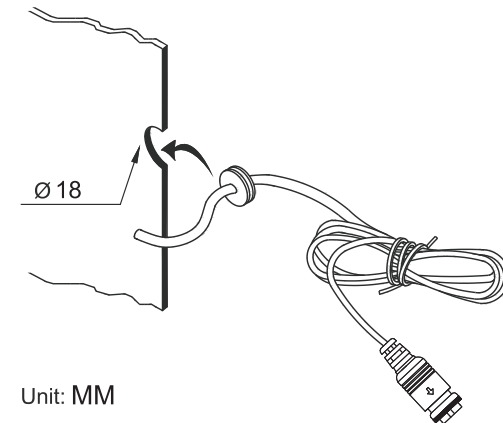

3

4