

● **BLAUPUNKT**

BLAUPUNKT
Brand
established
1924
GERMANY

VELOCITY POWER
CLASS AB AMPLIFIER with DSP
MPD 48 A

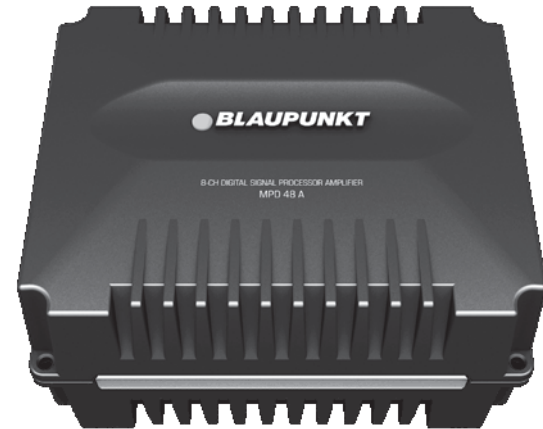

Enjoy it.



CAUTIONS

This device has been manufactured according to established safety guidelines. However, dangers may still occur if the safety notes in this manual is not observed. This manual is intended to familiarize the user with the device's important functions. Read this carefully, prior to using the car radio. Keep this manual in an easily accessible location. In addition, do observe the instructions of other devices used in conjunction with this device.

Installation Safety Notes

Always observe the following safety notes:

- Device must be used in a way that compliments safety of the user when driving the vehicle. It is recommended for the user to install at an appropriate location when operating the device. While driving, user is not recommended to use applications that can be prone to distraction.
- Before installation, disconnect the negative terminal of the battery. Refer to the safety vehicle manufacturer's user manual.
- Ensure positions of the holes are nowhere near the vehicle component to avoid any damage during drilling.
- Ensure cross section of the cables is no less than 2.5mm if the positive and the negative cables are too long. incorrect installation may result in malfunction of the device or the car sound system.
- Select a dry and well-ventilated location to install the device.
- The device must not be installed in overly exposed location.
- The installation location must be suitable for screw holes and stable ground support

General Safety Notes:

Observe the following for protection against injuries:

- User is advised to keep the volume of the car radio to a moderate level for the protection of the ears and to increase the ability to hear any emergency warning signals (e.g. police and ambulance sirens). Do not increase the car radio volume while the car radio is muted as it is not audible. The car radio volume can be too loud when the car radio is unmuted.

Disclaimer

- Blaupunkt is not liable for any loss or damage caused or resulting from unauthorized disassembly or modification to the product.
- In no event shall Blaupunkt be liable for any direct, indirect, punitive, incidental, special consequential damages, to property or life, improper storage, whatsoever arising out of or connected with the use or misuse of our products.
- USA & CANADA : Products not intended for sales in the United States and Canada. If purchased in the U.S. or Canada, this product is purchased as-is. No warranty, expressed or implied is provided in the U.S. and Canada.

Voltage Supply

- +12V : Positive connection terminal for car 12V power supply.
- GND : Power supply negative connection terminal.
- Firmly and carefully connect the ground lead to a bare metal point on the vehicle chassis.
- Operation temperature : 0° - 70°C

Compatible PC OS

- PC - with or higher than Windows XP
- Android - mainstream Android devices with Bluetooth

Scope of Delivery

- DSP Digital Signal Processor (202 x 168 x 52mm)
- 2.0m USB Cable
- Microphone (equipped with cable and fixed bracket, optional)
- Bluetooth Dongle (optional)
- Remote Controller
- 4 Tapping Screws (M4 x 25)
- Universal 20p Wiring Harness
- 4P Specific Power Cable

Disposal Notes



Do not dispose of your old unit in the household trash!
Use the return and collection systems available to dispose of the old device.

INPUT FUNCTION

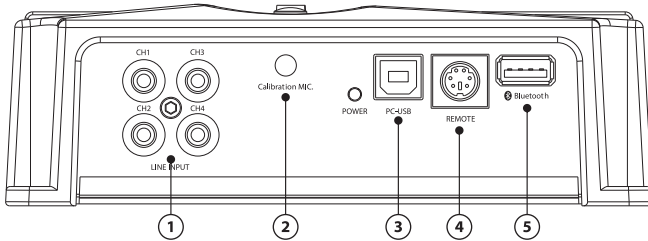

1. 4-channel low level input.
2. Auto calibration microphone input.
3. Connect to computer for software tuning.
4. Port for connecting the optional remote control.
5. Port for connecting the optional Bluetooth 5.0 device. (allows audio streaming between a smart phone and the MPD 48 A as well as the ability of the smart phone DSP control.)

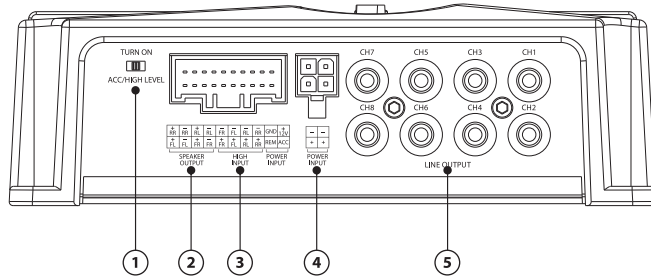

1. Used to select the desired MPD 48 A turn-On method. ACC=RCA Input, HIGH LEVEL=High Level (Signal sense).
2. 4-channel speaker output.
3. 4-channel high level input.
4. Use power input when loaded over 50W.
5. 8-channel low level RCA output.

SOFTWARE OPERATION (ANDROID)

EQ Tuning Interface



1. Crossover tuning interface.



2. Channel adjustment interface.



3. EQ adjustment interface.



4. Mixing adjustment interface.



4. Speaker curve.



5. EQ curve.

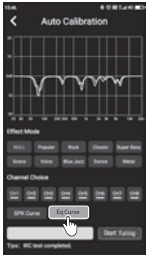

6. Speaker curve and EQ curve.

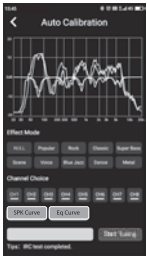

Advanced Setup

1. Click on Advanced Setup.



2. Enter confirmation code "88888888".

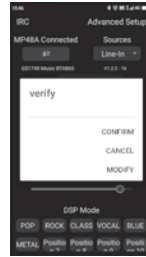

3. Enter EQ tuning.

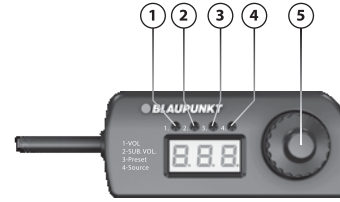
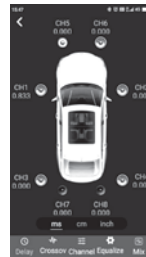

1. Main Volume

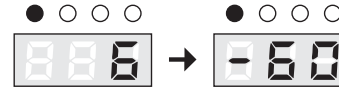

2. Bass Volume



3. Preset modes, choose among 10 modes (P-0~P10).

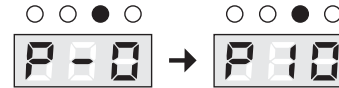

4. Source switching (switch between Hi level input and bluetooth input).

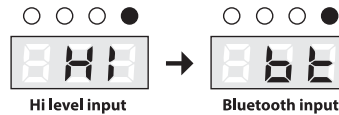

5. Tap to switch function, press to mute and rotate to tune each function.



Audio

- RMS Power : 25W x 4(4Ω) 40W x 4(2Ω)
- DSP Resolution : 24 Bit
- DSP Power : 48 kHz
- Output Power RMS @ 4 Ohms (≤1% THD +N) : 4 x 25W
- Output Power RMS @ 2 Ohms (≤1% THD +N) : 4 x 40W
- Distortion (THD) : <0.005%
- Damping Factor : >70
- Sampling Rate : 48kHz
- Signal Converter A/D : Cirrus Logic
- Signal Converter D/A : Cirrus Logic
- FLAC
- Low Pass Filter
- High Pass Filter

Input

- 4 x RCA/ Aux-in
- 4 High Level Speaker Input
- 1 x Remote-in
- 1 x USB
- RCA/ Cinch Sensitivity : 250mV
- Impedance RCA : ∞
- Impedance High Level : 1000 Ohms
- S/N Ratio Analog-in : 100dB

Output

- 8 x RCA/ Cinch
- 4 High Level Speaker Output
- 1 x Remote-out
- Voltage RCA/ Cinch : 4V RMS

Feature

- 4 x 30W, Class AB Amplifier
- Max. Output Power : 200W
- Frequency Response : 10Hz~20kHz
- Max. Current Consumption : 30A
- Dimension (W x H x D) : 202 x 168 x 52mm
- Weight : 1.15 kg

WIRING DIAGRAM



Attach the fixed bracket to the headrest of the driver seat.
Use the bracket to support the microphone in tuning process.

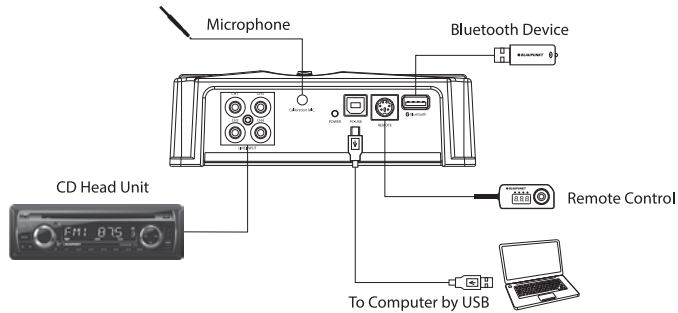

Car Specific Wiring Method

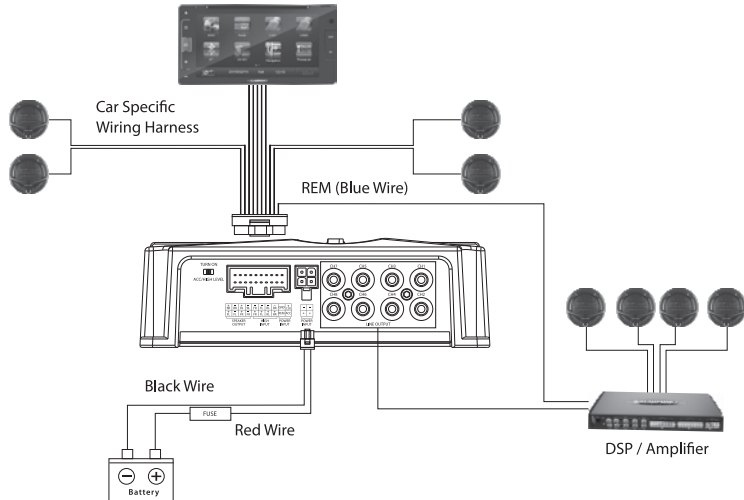

SOFTWARE OPERATION (ANDROID)

Android Mobile Application

Search "Blaupunkt MPD Tuner" on Google Play to download the App.



Bluetooth Connection

1. Turn on the bluetooth connection, click the tuning software APP, and click to start the connection after automatically searching for the device.

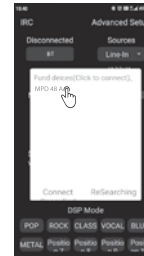

2. "MPD 48 A" has been connected successfully, and the volume can be adjusted.



Auto Calibration

1. Click IRC to start auto calibration.



2. Click to start tuning.

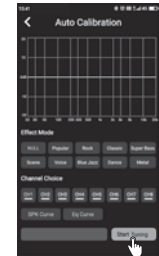

3. Waiting for auto calibration.

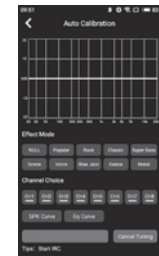

SOFTWARE OPERATION (WINDOWS)

7. Scene

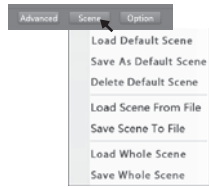

8. a) Advanced - Auto Calibration

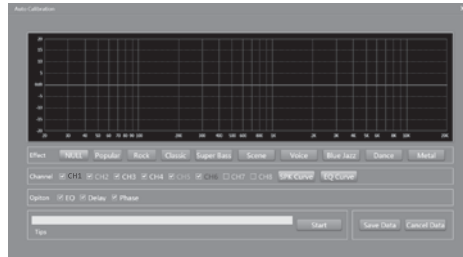
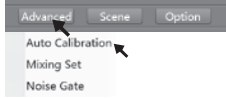

b) Advanced - Mixing Set

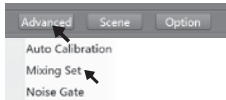

c) Advanced - Noise Gate

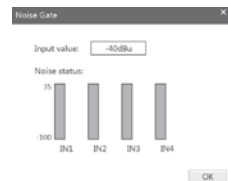

WIRING DIAGRAM

Universal Wiring Method

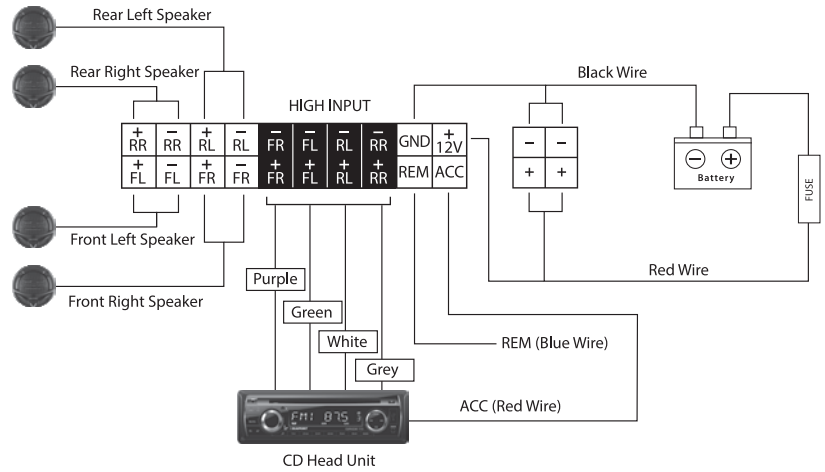

SOFTWARE OPERATION (WINDOWS)

Blaupunkt MPD 48 A Software

Visit www.blaupunkt.com/ase to download the software.



Blaupunkt.exe

Car entertainment enthusiast / experts may now begin to tune signal details. Enhance the sound effect according to your very own preference for optimum music enjoyment with the DSP software.

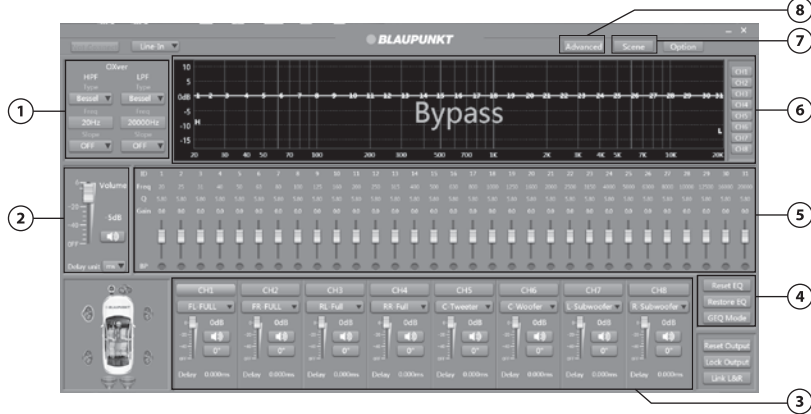

Channel Panel (31-band Tuning)

1. Xover



- Crossover frequency setting :
 - 3 Types of High-pass frequency
 - 3 Types of Low-pass frequency

SOFTWARE OPERATION (WINDOWS)

3. Channel Control

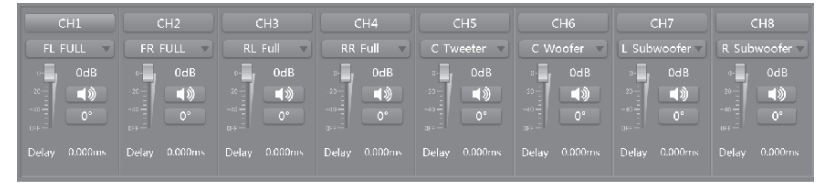

4. a) Click "Reset EQ", choose whether to reset all EQ.



b) Click "GEQ Mode", choose whether to convert GEQ mode to PEQ mode



5. 31-band equalizer control



6. 31-band tuning waveform

