



Instruction Manual

720p HD Projector - BHP720H



Enjoy it.

CONTENTS



General Safety	4
Product Overview	8
Remote Control	10
Placing Projector	12
First Time Setup	13
Projector Lens Focus	14
Settings	
Picture	15
Sound	16
Option	17
Time	18
Specifications	19
Customer Helpline	Last Page

GENERAL SAFETY

Read this manual thoroughly before you start using the Projector.

Store this manual, the completed warranty card, your receipt and the product packaging. The safety precautions instructions reduces the risk of fire, electric shock and injury when correctly complied to.

Please follow all instructions and take notice of all warnings.

 <p>CAUTION RISK OF ELECTRIC SHOCK DO NOT OPEN</p>		<p>The lightning flash with symbol within the triangle is intended to warn you of a non-insulated dangerous voltage in the product's enclosure that could be of sufficient magnitude to generate a risk of electric shock to persons.</p>
<p>The cover (or back) of the unit should not be removed to prevent risk of electric shock. This unit must be serviced by a qualified service personnel only.</p>		<p>The exclamation point within the triangle is intended to warn you to the presence of important operating and maintenance instructions in the documents included with the product.</p>

IMPORTANT INFORMATION

The lightning flash symbol within the triangle is intended to warn you of non-insulated dangerous voltage the product's enclosure that could be of sufficient magnitude to generate a risk of electric shock to persons.

- Only using furniture that can safely support the Products.
- Ensure the Product is not overhanging the edge of the supporting furniture.
- Do not place the product on a high furniture without securing both the furniture and the product to a stable support.
- Do not place the product on cloth or other conductive materials.
- Warn children of the dangers of climbing on furniture to reach the projector or its controls and to call for an adult to assist.

GENERAL SAFETY (CONT.)

IMPORTANT INFORMATION

- Do not expose this appliance to rain or moisture as it may result in fire or an electric shock hazard
- Do not tamper or change or modify the product in any way.
- Only use Accessories outlined and recommended by the manufacturer.
- Please do not expose the product to splashing or water contact
- Please do not place any object on top of the product including objects filled with liquids such as vases.
- Replace with same or equivalent type.

Installation

Please follow instruction when installing this product in accordance with the instruction manual. This product must be positioned in a sufficiently stable location, it can be potentially hazardous due to falling and can cause injury, particularly to children if it positioned incorrectly.

- Before installing this Projector set, make sure your outlet voltage corresponds to the voltage stated on the product rating label
- Do not use a damaged power cord, plug or loose outlet. Doing so may cause an electric shock.
- Do not plug several devices into the same outlet. Doing so may cause the outlet to overheat and start a fire. Make sure the outlet is readily accessible during operation of the equipment.
- Do not bend, twist or kink the power cord excessively.
- Do not allow anything to rest on or roll over the power cord. Doing so may cause a fire or an electric shock.
- Do not run the power cord near heat-producing appliances such as radiators, stoves or irons. The excessive heat could melt the insulation and expose live wires, resulting in fire or electric shock.
- Unplug this Projector during lightning storms or when unused for long periods of time. Not doing so may result in fire or electric shock.
- Do not cover the ventilation openings of the product with items such as newspapers, tablecloths, curtains etc or insert objects into the slots available on the products. As this could result in the product temperature rising and could cause a fire.
- If you notice any unusual odors or smoke around the unit, immediately disconnect the unit from the outlet and contact the service center. Failure to do so may result in fire or electric shock.
- When not using the unit for long periods of time or when you are moving the unit please ensure to disconnect the power cord from the wall socket.

GENERAL SAFETY (CONT.)

- Please beware that Dust could accumulate over time on the unit and cause it to generate heat and or deteriorate insulation, which in turn may result in an electrical fire.
- The product is not intended for use by persons (including children) with reduced physical, sensory or mental capabilities, or young children of any age, They must be supervised product by a person responsible for their safety.
- Batteries from the remote control must be only removed by an adult, the adult must ensure to keep them out of reach of infants and children. Seek medical attention immediately if a child has swallowed a battery.
- Batteries (battery pack or batteries installed) shall not be exposed to excessive heat such as sunshine, fire or the like.
- To maintain the product do not use any chemical or cleaning agent or wet cloth, please only ensure to utilize a dry cloth to wipe it down from marks or dust and only after unplugging the product from the power socket.
- Please ensure to contact our call center for any repair or service required for the products.

! CAUTION !

DO NOT look directly into Project LENS. This can cause damage to a persons or childrens eyes. Take all nessecary precautions to make sure that no one looks into the LENS while turned on.

MAKE SURE this project is out of reach of children or baby so that they do not stand and look into the project LENS.

DO NOT cover the vents, the vents are needed to let out hot air. Placing objects near or covering the vents can cause the product to overheat and permanently damage the projector.

GENERAL SAFETY (CONT.)

Please make sure upon positioning this product, the place is:

- Not wet or damp and Well ventilated
- Away from direct sunlight or heaters.
- Away from splashes or food.
- Protected from excessive dust or grease.
- Do not install this equipment in a confined space such as a bookcase or similar unit.
- Do not install the Projector set near heat sources such as radiators, stoves or other audio visual equipment that produce heat.
- Do not place containers with liquids, if liquid falls inside the products it may result in short-circuit, fire or electric shock.
- Do not place small metallic objects on top of the unit. Metal object falls inside the product it may result in short-circuit, fire or electric shock.
- Do not use or store flammable or combustible materials near the unit. Doing so may result in fire or explosion. Do not place any naked flame sources, such as lit candles, cigarettes or incense sticks on top of the Projector set.
- Install the unit at a reasonable distance from the wall to ensure sufficient ventilation.



“HDMI, the HDMI logo and High-Definition Multimedia Interface are trademarks or registered trademarks of HDMI Licensing LLC.”

PRODUCT OVERVIEW

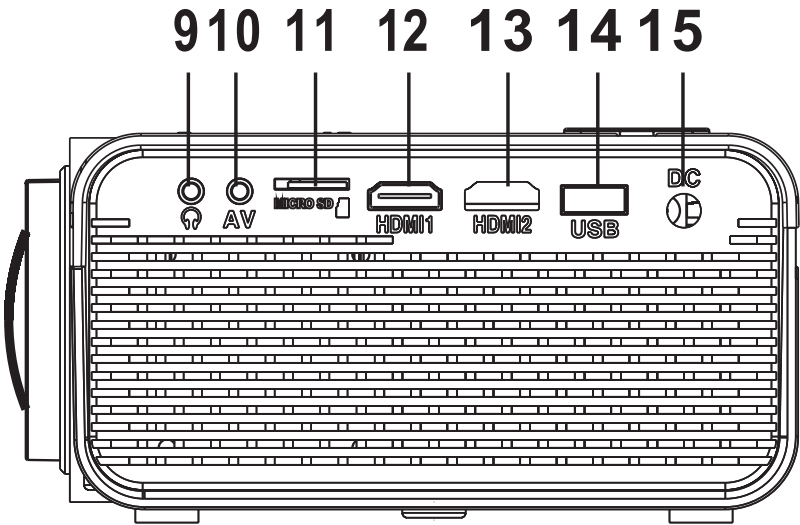
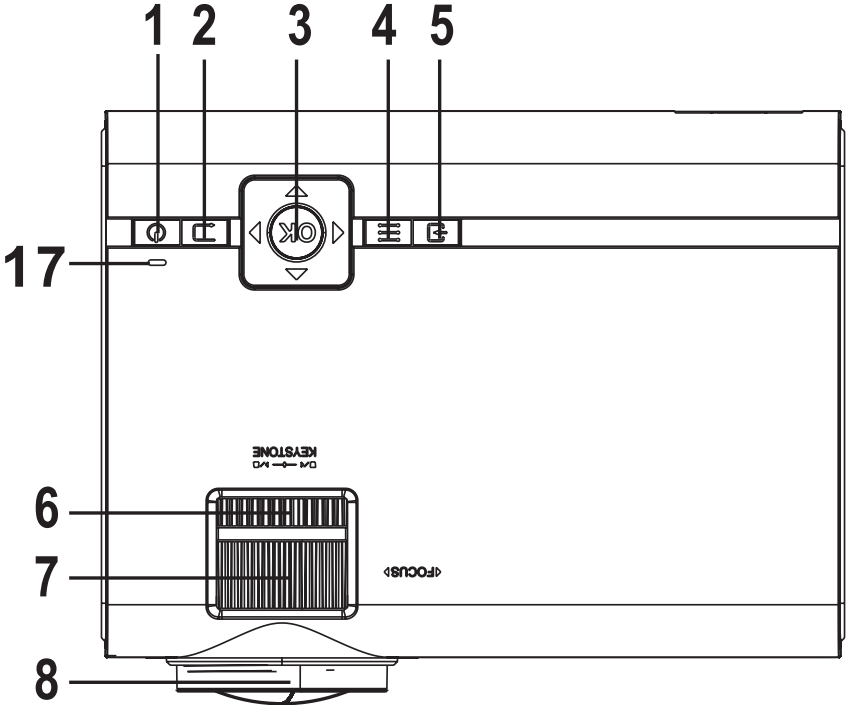

PRODUCT OVERVIEW (Cont.)

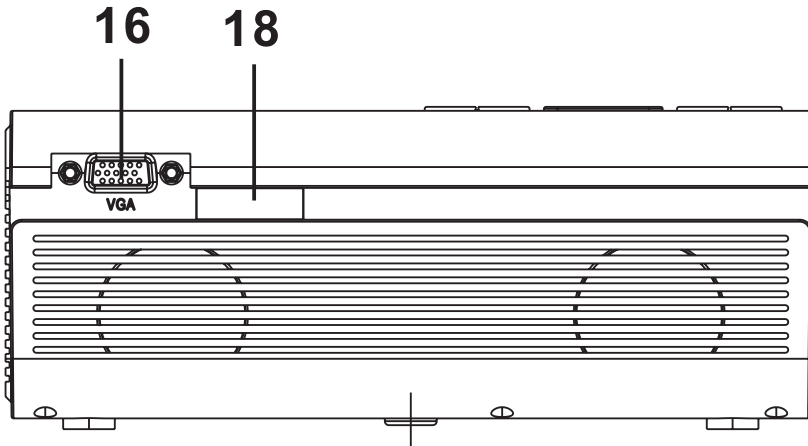

1. Power Button
2. Return / Back Button
3. Navigation Arrows / OK button
4. Menu
5. Source (input) button
6. Tilt Dial
7. Focus Dial
8. Lens
9. Headphone Jack
10. AV In
11. Micro SD Card Slot
12. HDMI 1
13. HDMI 2
14. USB Input
15. DC In (power)

REMOTE CONTROL

Your projector comes with a Remote Control to access and control your projector from a distance. (Batteries not included).

Make sure to place the batteries into the back compartment of the remote control in the correct way. The polarities on the battery (+/-) must match the polarities on the remote control in order for the remote to work.

Power

Press to power ON.

Press twice to power OFF.

◀◀ Previous / Next ▶▶

Press to skip between chapters or tracks.

■ Stop

Press to stop playback.

Flip

Press to flip display image 180°.

▶|| Play/Pause

Press to play or pause an individual chapter or track.

Arrows/OK

Press to navigate and confirm selections in Settings and other menus.

Menu

Press to access projector Settings.

Go To/Number Keypad

Press to enter specific chapter or track numbers. Use Play button to begin playing.

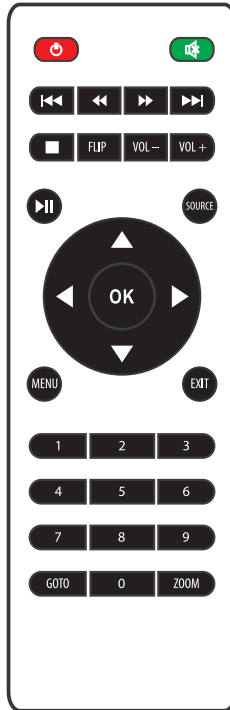

Mute

Press to mute volume.

◀◀ Back / Fwd ▶▶

Press to search through an individual chapter or track.

VOL+ / VOL-

Press to adjust audio level.

Source

Press to select media source (AV, PC, HDMI, MEDIA).

Exit

Press to exit menus.

Zoom

Press to zoom display image in or out.

REMOTE CONTROL (cont.)

Using the Remote Control

- Do not mix old and new batteries in the remote
- Do not use different types of battery
- If you do not intend to use the unit for a long time, please remove batteries from the remote to avoid accident.
- Keep batteries away from children and pets.
- Never throw batteries into a fire.
- Do not drop, or impact the remote control as it void warranty immediately.
- The remote control operate at a range of 5 to 6M effectively
- Do not expose the remote control sensor to a bright light.

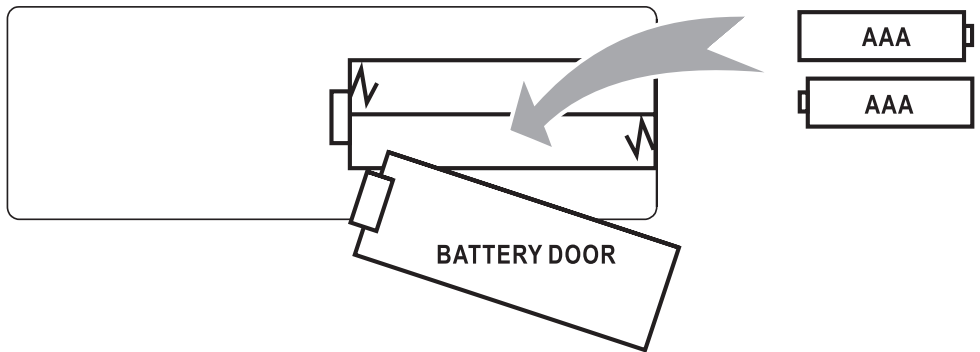

PLACING PROJECTOR

Your projector can be installed in four different configurations:



Front Facing Table

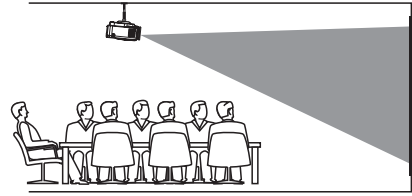

Front Ceiling

(A Projector Mount is required, Not Included)

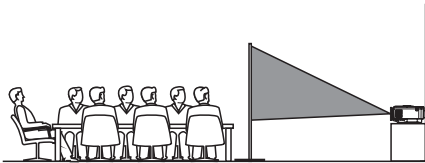

Behind Projector Screen

(Special Rear Projection Screen is required, Not Included)

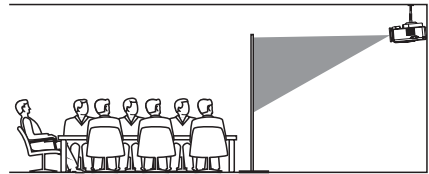

Ceiling Behind Projector Screen

(A Projector Mount is required, Special Rear Projection Screen is required, Not Included)

DISTANCE BETWEEN THE PROJECTOR AND THE SCREEN.

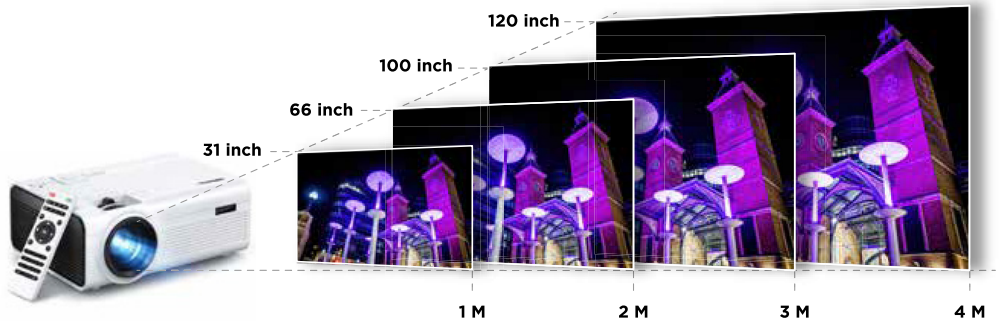



1 metre	-	31" (inches)	3 metre	-	100" (inches)
2 metre	-	66" (inches)	4 metre	-	120" (inches)

FIRST TIME SETUP

Make sure to place the projector on a flat and stable surface that is level. So that the projector projects the video/image onto the wall nice and straight.

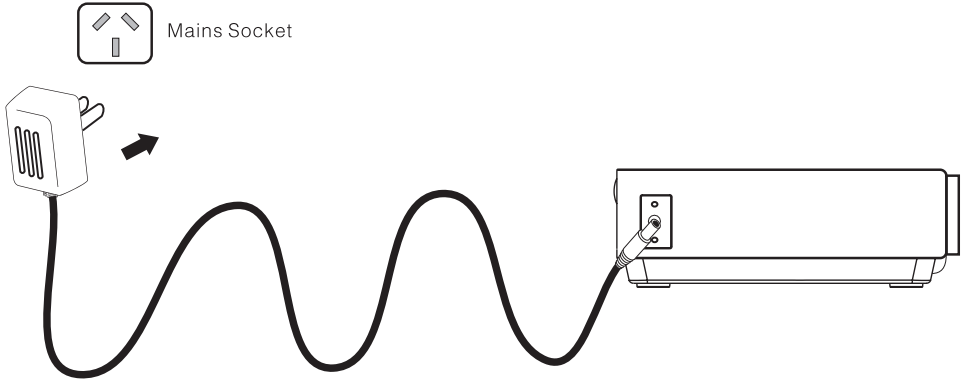
1. Plug in the Power cable into the DC Port of the Projector. Then plug in the other end into a wall power socket.



2. Once the power is plugged in, Press the  button located at the top to turn on the projector.
3. You can now need to connect a source of media to play from to project onto the wall. This can be through:
 - a. **HDMI 1**
 - b. **HDMI 2**
 - b. **USB**
 - c. **AV IN** (Red, White, Yellow to 3.5mm Jack)
 - d. **MICRO SD**
4. When you plug in a media source, you must select the **INPUT** source you want to view. By doing this, press the  button on the unit or SOURCE on the Remote for the **SOURCE** menu to appear, then navigate with the arrow buttons, and press the Circle button to select the **SOURCE**.
5. Once you have selected the **SOURCE**, you can now adjust the **VOLUME** and manually adjust the focus of the projector lens to suite your needs depending on the distance from the wall your projector is.

PLEASE FOLLOW THE NEXT STEPS ON HOW TO MANUALLY ADJUST THE FOCUS.

PROJECTOR LENS FOCUS

Once you have your Projector all setup, input mode selected, power turned on. You can now adjust the focus and keystone correct (tilt forward or backwards) depending on the orientation of your projector.

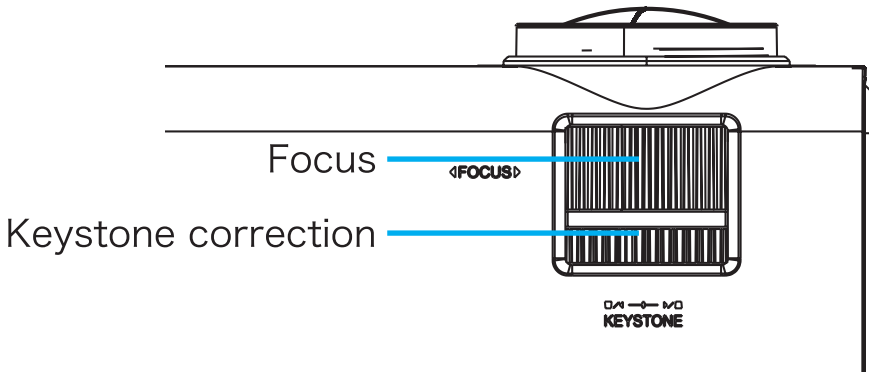

1. Turn the **FOCUS** dial to adjust the LENS focus.
LEFT DIRECTION - Is toward larger screen sizes best focus point.
RIGHT DIRECTION - Is towards smaller screen sizes best focus point.



2. Turn the **KEYSTONE** dial to adjust the Tilt Direction.
RIGHT DIRECTION - Tilts the screen backwards (top of screen)
This is best for aiming the project up higher on the wall. Tilting the screen backward will straighten out the picture.
LEFT DIRECTION - Will tilt the screen back to the standard position.

SETTING - PICTURE

To Access the setting **PICTURE** menu:

1. Press the **MENU**  button located on the top of the Projector or the **MENU** button on the Remote Control.
2. With the directional keys, Press the **RIGHT**  arrow button to enter **PICTURE** settings.
3. To navigate back to PICTURE/SOUND/OPTION, with nothing selected, Press **LEFT**  button.



PICTURE MODES: Standard, Soft, Vivid, User
(contrast, brightness, sharpness, colour).





COLOUR TEMP: Adjust between Medium, Cool, Warm.

ASPECT RATIO: 3 modes: Auto, 4:3, 16:9

NOISE REDUCTION: Off, Low, Middle, High, Default.

SETTING - SOUND

To Access the setting **PICTURE** menu:

1. Press the **MENU**  button located on the top of the Projector or the **MENU** button on the Remote Control.
2. With the directional keys, Press the **DOWN**  button, when on **SOUND**, Press the **RIGHT**  arrow button to enter **SOUND** settings.
3. To navigate back to PICTURE/SOUND/OPTION, with nothing selected, Press **LEFT**  button.



SOUND MODES:

Standard, Music, Movie, Sports, User

When on User mode, you can adjust more settings such as Treble & Bass.

BALANCE:





Adjust the Audio Balance of the left or right speaker.

SURROUND SOUND:

Adjust between ON or OFF.

SETTING - OPTION

To Access the setting **OPTION** menu:

1. Press the **MENU**  button located on the top of the Projector or the **MENU** button on the Remote Control.
2. With the directional keys, Press the **DOWN**  button, when on **OPTION**, Press the **RIGHT**  arrow button to enter **OPTION** settings.
3. To navigate back to PICTURE/SOUND/OPTION, with nothing selected, Press **LEFT**  button.

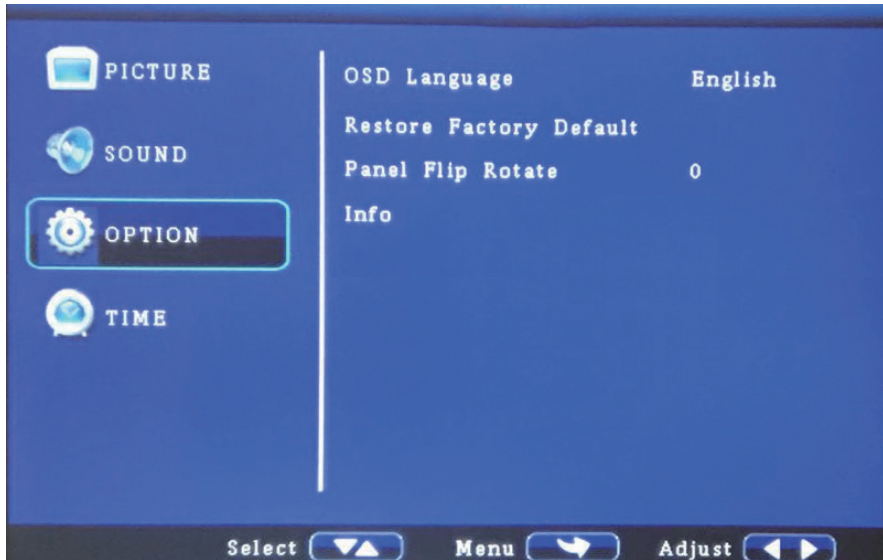

OSD LANGUAGE: Adjust between Languages: English (default)





RESTORE FACTORY: Press Yes to reset your projector settings and device.

PANEL FLIP ROATATE: Press to flip th screen between Rotate: 0, 1, 2, 3...

KEYSTONE CORRECT: Adjust different angle between -22° to 22°.

SETTING - TIME

To Access the setting **TIME** menu:

1. Press the **MENU**  button located on the top of the Projector or the **MENU** button on the Remote Control.
2. With the directional keys, Press the **DOWN**  button, when on **TIME**, Press the **RIGHT**  arrow button to enter **TIME** settings.
3. To navigate back to PICTURE/SOUND/OPTION, with nothing selected, Press **LEFT**  button.



CLOCK: Set the Clock to Day / Month / Year / Hour / Minutes

OFF TIMER: Set Turn OFF timer to Day / Hour / Minutes

ON TIMER: Set Turn ON timer to Day / Hour / Minutes

SLEEP TIMER: Set when you want the projector to turn off, with:
OFF / 10mins / 20mins / 30mins / 60mins / 90mins /
120mins / 180mins / 240mins.

AUTO SLEEP: Select to auto sleep functions:
NEVER / 4 Hours / 6 Hours / 8 Hours

SPECIFICATIONS

DISPLAY	Supports up to 1080p (1920x1080)	
Resolution	1280 x 720 Native Resolution	
Projection Distance	1-4 Metres	
Projection Size	31" to 120" (inches)	
Lumens	2000 Peak Lumens (90 ANSI)	
Contrast Ratio	500 : 1	
Aspect Ratio	16:9, 4:3, AUTO	
Multimedia Playback Format under USB Mode	Movie: AVI/FLV/RMVB/MKV/MP4/3GP/MOV/MPG/MPEG/TS/TP/VOB	
	Music: MP3/WMA/OGG/AAC/FLAC	
	Photo: JPG/BMP/PNG	
Power Source	12VDC 4A	
USB	5V  max. 500mA	
Dimensions	203 (w) x 150 (d) x 82 (h) mm	
Weight	Net: 0.9 kg	
	Gross: 1.28 kg	
Accessories	1 x Instruction Manual	1 x Remote Control
	1 x DC Supply Cord	1 x Warranty Card
	1 x Lens Cover	

NOTE: This document is for reference only, the operation interface is subject to software.



CUSTOMER SUPPORT:

info@ayonz.com

DISTRIBUTED BY:

Ayonz Pty Ltd