

**BLAUPUNKT**

BLAUPUNKT  
Brand  
established  
1924  
GERMANY

# VELOCITY POWER

## CLASS AB AMPLIFIER with DSP

### MPD 1012 A



*Enjoy it.*

Operating and Installation Instructions



# INTRODUCTION

---

This device has been manufactured according to established safety guidelines. However, dangers may still occur if the safety notes in this manual is not observed. This manual is intended to familiarize the user with the device's important functions. Read this carefully, prior to using the car radio. Keep this manual in an easily accessible location. In addition, do observe the instructions of other devices used in conjunction with this device.

## Installation Safety Notes

Always observe the following safety notes:

- Device must be used in a way that compliments safety of the user when driving the vehicle. It is recommended for the user to install at an appropriate location when operating the device. While driving, user is not recommended to use applications that can be prone to distraction.
- Before installation, disconnect the negative terminal of the battery. Refer to the safety vehicle manufacturer's user manual.
- Ensure positions of the holes are nowhere near the vehicle component to avoid any damage during drilling.
- Ensure cross section of the cables is no less than 2.5mm if the positive and the negative cables are too long. incorrect installation may result in malfunction of the device or the car sound system.
- Select a dry and well-ventilated location to install the device.
- The device must not be installed in overly exposed location.
- The installation location must be suitable for screw holes and stable ground support

## General Safety Notes:

Observe the following for protection against injuries:

- User is advised to keep the volume of the car radio to a moderate level for the protection of the ears and to increase the ability to hear any emergency warning signals (e.g. police and ambulance sirens). Do not increase the car radio volume while the car radio is muted as it is not audible. The car radio volume can be too loud when the car radio is unmuted.

## Disclaimer

- Blaupunkt is not liable for any loss or damage caused or resulting from unauthorized disassembly or modification to the product.
- In no event shall Blaupunkt be liable for any direct, indirect, punitive, incidental, special consequential damages, to property or life, improper storage, whatsoever arising out of or connected with the use or misuse of our products.
- USA & CANADA : Products not intended for sales in the United States and Canada. If purchased in the U.S. or Canada, this product is purchased as-is. No warranty, expressed or implied is provided in the U.S. and Canada.

## Voltage Supply

- +12V : Positive connection terminal for car 12V power supply.
- GND : Power supply negative connection terminal.
- Firmly and carefully connect the ground lead to a bare metal point on the vehicle chassis.
- Operation temperature : 0° - 70°C

## Compatible PC OS

- PC - with or higher than Windows XP

## Scope of Delivery

- DSP Digital Signal Processor (279 x 200 x 57mm)
- 2.0m USB Cable
- Remote Controller (optional)
- 4x Gaskets
- 4x Tapping Screws (4 x 18mm)
- 4x Machine Screws (4 x 6mm)
- 4x Mounting Bracket (46x22x2mm)
- Universal 20p Wiring Harness
- 4P Cable

## Disposal Notes



Do not dispose of your old unit in the household trash!  
Use the return and collection systems available to dispose of the old device.

# INPUT FUNCTION

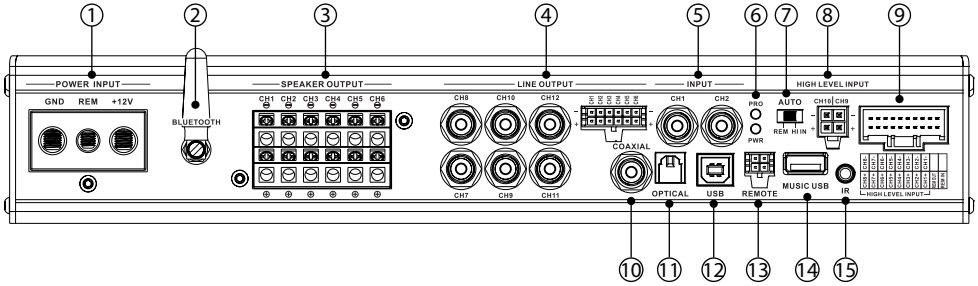

1. Power Input
2. BT Antenna
3. Speaker Output
4. Low Level RCA Output
5. Low Level RCA Input
6. Power & Protection LED
7. HI IN/REM Convertor
8. CH9/ CH10 Hi Level Input
9. CH1~CH8 Hi Level Input/ Remote In/ Remote Out
10. Coaxial Input
11. Optical Input
12. USB2.0 Port
13. Remote Control
14. USB Player
15. IR

# INSTALLATION



# WIRING DIAGRAM

## Car Specific Wiring Method

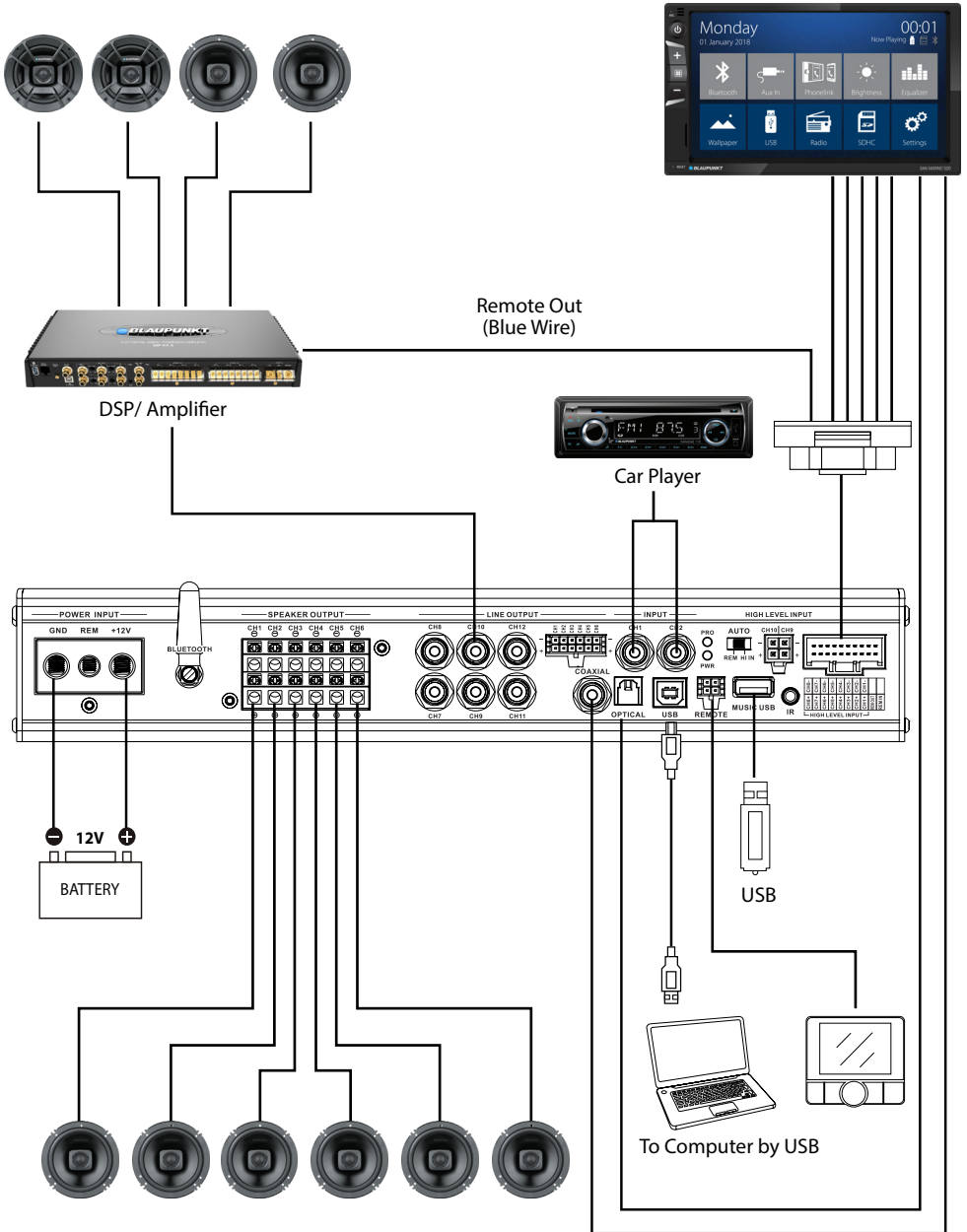

# SPECIFICATION

## Audio

- RMS Power : 80Wx6(4Ω),120Wx6(2Ω)
- DSP Resolution : 24 Bit
- DSP Power : 48 kHz
- Output Power RMS @ 4 Ohms (≤1% THD +N) : 80Wx6
- Output Power RMS @ 2 Ohms (≤1% THD +N) : 120Wx6
- Distortion (THD) : <0.005%
- Damppling Factor : >70
- Operating Voltage : 10 -14.4V
- Sampling Rate : 96kHz
- Signal Converter A/D : Burr-Brown
- Signal Converter D/A : Burr-Brown

## Input

- 2 x RCA/ Aux-in
- 1 x COAX-in
- 10 High Level Speaker Input
- 1 x Optical SDPIF
- 1 x Remote-in
- 1 x USB
- RCA/ Cinch Sensitivity : 300mV
- High Level Input Sensitivity : 2.5V
- Impedence High Level : 100 Ohms
- S/N Ratio Analog-in : 100dB

## Output

- 12 x RCA/ Cinch
- 6 High Level Speaker Output
- 1 x Remote-out
- Voltage RCA/ Cinch : 4V RMS

## Feature

- Class AB Amplifier
- 31-Band Equalizer/ Phase & Time Aligment Setting
- Max. Output Power : 960W
- Frequency Response : 10Hz-20kHz
- Max. Current Consumption : 40A x 2
- Dimension (W x H x D) : 324 x 200 x 57mm
- Weight : 3.6 kg

## Accessories



4x Tapping Screws  
(4x18mm)



4x Machine Screws  
(4x6mm)



4x Gaskets

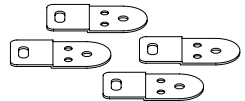

4x Mounting Bracket  
(46x22x2mm)



2.0m USB Cable



1x 4P Cable



1x Universal 20P Wiring  
Harness

# SOFTWARE OPERATION (WINDOWS)

## Blaupunkt MPD 1012 A Software

Visit [www.blaupunkt.com/ase](http://www.blaupunkt.com/ase) to download the software.



MPD 610 A MPD 1012 A.exe

Car entertainment enthusiast / experts may now begin to tune signal details. Enhance the sound effect according to your very own preference for optimum music enjoyment with the DSP software.

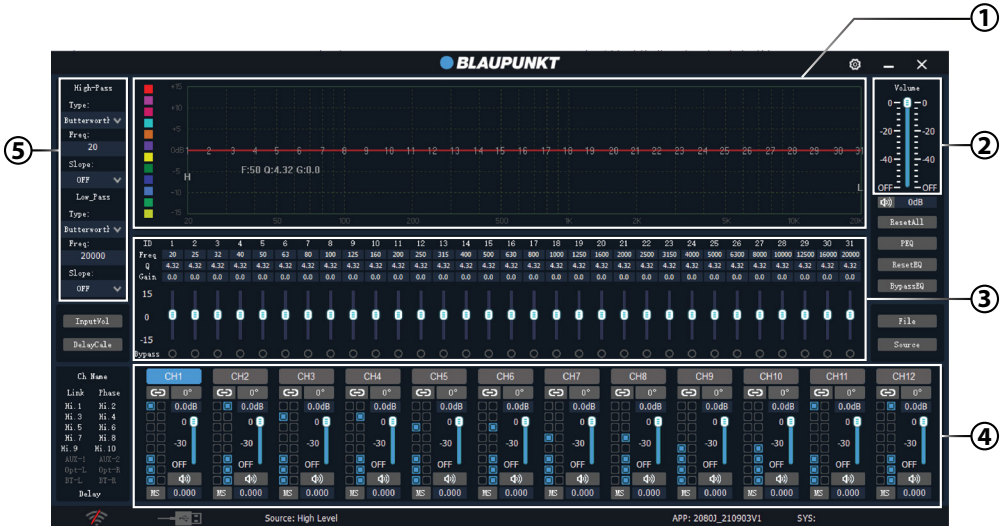

Channel Panel (31-band Tuning)

### 1. 31-Band Tuning Waveform

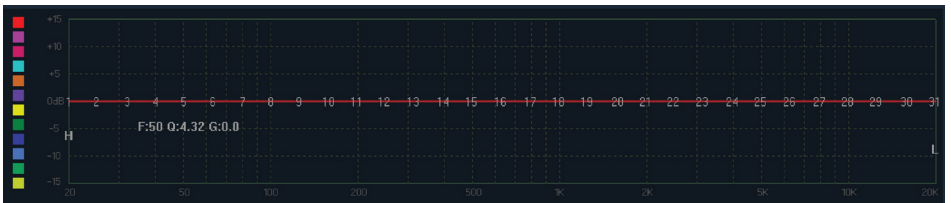

### 2. Main Volume Control

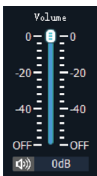

# SOFTWARE OPERATION (WINDOWS)

## 3. 31-band Equalizer Control



## 4. 12-Channel Control

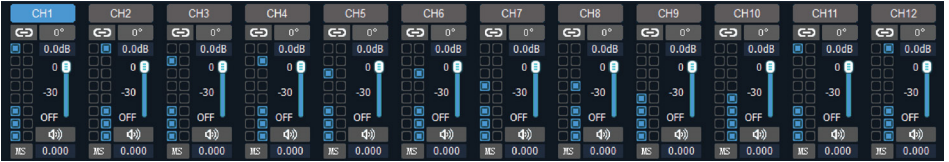

- ## 5. Crossover Frequency Setting :
- 3 Types of High-pass Frequency
  - 3 Types of Low-pass Frequency

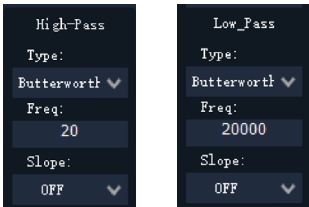



## TROUBLESHOOTING

If any of the following problem occur, please resort to Troubleshooting for the possible solutions. Consult Blaupunkt authorized dealer if problem persist.

Problem	Solution
Amplifier power up failure	Examine if the ground connection is intact.
	Examine if remote input has at least 5V DC.
	Examine if battery power is connected correctly to the + terminal.
	Ensure supplied voltage is minimum 12V.
	Examine if fuse is broken and replace if necessary.
	Restart the device if protection LED light is on.
No sound output	Examine fuses and replace if necessary.
	Examine ground connection is intact.
	Examine if remote input has at least 5V DC.
	Examine if RCA audio cables are connected to the right inputs.
	Examine if speaker wiring is intact.
Low sound output	Reset Level Control
	Examine the Crossover Control setting.
Buzzing noise	Observe if the device is still producing noise after turning on and off the amplifier. If yes, examine if the cables are correctly connected and if the cables and radio are in good condition.
	Repair or replace if the cables or the radio are not in good condition.
Squealing noise interference	Ensure RCA connections are properly connected.
Distorted sound output	Ensure input level of the device matches the signal level of the head unit.
	Always set the input level to the lowest.
	Examine if crossover frequency is set correctly.
	Examine if speaker wire had short-circuit.
Amplifier temperature increased	Examine the minimum speaker impedance for the amp models is correct.
	Ensure good air ventilation around the device. Add external cooling fan if necessary.
Engine noise (static sound) interference	Usually caused by poor RCA cable quality, which release noise. Use only the best quality cables, and route them away from power cables.
Engine noise (alternator whine) interference	Examine if RCA cable are nowhere near or attached to the vehicle chassis.
	Examine if head unit is properly connected to the wires.





