

● **BLAUPUNKT**



CLASS AB DSP
WITH AMPLIFIER **GTD 1407 A**



Enjoy it.

Operating and Installation Instructions

CAUTIONS

This device has been manufactured according to established safety guidelines. However, dangers may still occur if the safety notes in this manual is not observed. This manual is intended to familiarize the user with the device's important functions. Read this carefully, prior to using the car radio. Keep this manual in an easily accessible location. In addition, do observe the instructions of other devices used in conjunction with this device.

Installation Safety Notes

Always adhere to the following safety guidelines:

- Use the device in a manner that enhances the user's safety while operating the vehicle. It is advisable for the user to install the device at an appropriate location during operation. While driving, it is not recommended for the user to use applications that may lead to distraction.
- Before installation, disconnect the negative terminal of the battery. Refer to the safety vehicle manufacturer's user manual.
- Ensure that the positions of the holes are nowhere near the vehicle components to avoid any damage during drilling.
- Ensure cross section of the cables is not more than 5mm if the positive and the negative cables are too long. Incorrect installation may result in malfunction of the device or the car sound system.
- Select a dry and well-ventilated location to install the device.
- The device must not be installed in overly exposed location.
- The installation location must be suitable for screw holes and stable ground support

General Safety Notes:

Follow the guidelines below to protect against injuries:

- Users are advised to maintain the volume of the car radio at a moderate level to safeguard their ears and enhance their ability to hear emergency warning signals (e.g., police and ambulance sirens). Avoid increasing the car radio volume while it is muted, as it may not be audible. The car radio volume can become excessively loud when unmuted.

Disclaimer

- Blaupunkt is not liable for any loss or damage caused or resulting from unauthorized disassembly or modification to the product.
- Under no circumstances shall Blaupunkt be held liable for any direct, indirect, punitive, incidental, or special consequential damages, whether related to property or life, arising out of or connected with the use or misuse of our products, including but not limited to issues of improper storage.
- USA & CANADA: This product is not intended for sale in the United States and Canada. If acquired in the U.S. or Canada, it is obtained on an "as-is" basis. No warranty, whether express or implied, is provided in the U.S. and Canada.

Voltage Supply

- +12V : Positive connection terminal for car 12V power supply.
- GND : Power supply negative connection terminal.
- Firmly and carefully connect the ground lead to a bare metal point on the vehicle chassis.
- Operation temperature : 0° - 70°C

Compatible OS

- PC - Windows XP or higher
- Mobile Phone - Android 5.0 or higher
- iOS 12.0 or higher

Contents in Box

- Digital Signal Processor (186 x 120 x 46mm)
- 4x Tapping Screws (4x20mm)
- 1x 2.0m USB Cable
- 1x Universal 20P Wiring Harness
- 1x Wired Remote Control (Optional)

Disposal Notes



Do not dispose of your old unit in the household trash!
Use the return and collection systems available to dispose of the old device.

This manual may be updated from time to time without any notice. Visit www.blaupunkt.com for more info.

INPUT FUNCTION

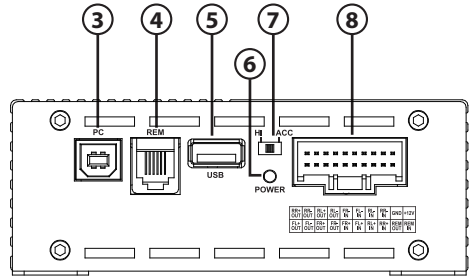
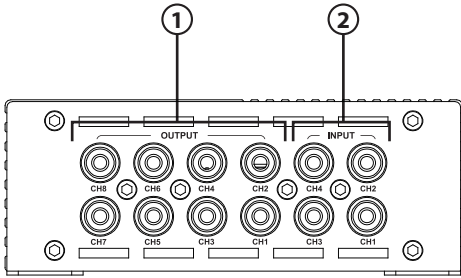

- 1. Ch1~Ch7/8 Low Level Outputs
- 2. Ch1~Ch4 Low Level Inputs
- 3. USB 2.0 Port
- 4. Remote Control Input
- 5. USB Player
- 6. Power & Protection LED
- 7. HI/ ACC Converter
- 8. Hi Level Inputs/ Speaker Outputs/ Remote In/ Remote Out

INSTALLATION

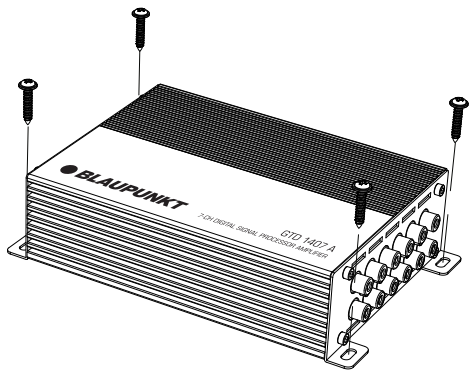
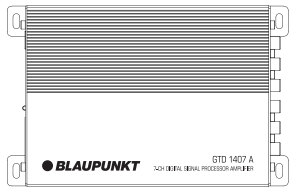
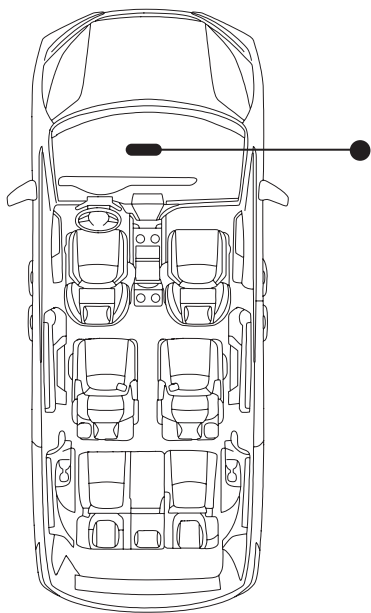

SPECIFICATION

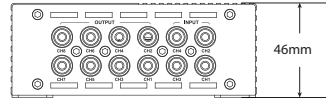
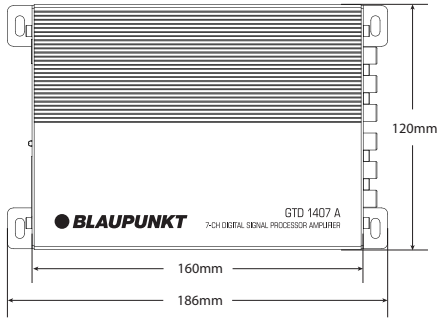

Audio

- DSP RMS Power : 25W x 4(4Ω), 40W x 4(2Ω)
- DSP Resolution : 24 Bit
- DSP Output Power RMS @ 4 Ohms (≤1% THD +N) : 25Wx4
- DSP Output Power RMS @ 2 Ohms (≤1% THD +N) : 40Wx4
- Distortion (THD) : ≤0.05%
- Damping Factor : >70
- Operating Voltage : 9 -16V
- Sampling Rate : 48kHz
- Signal Converter A/D : MPV8428P
- Signal Converter D/A : Cirrus Logic CS4344

Input

- 4 x RCA/ Aux-in
- 4 x High Level Speaker Input
- 1 x Remote-in
- 1 x USB

- RCA/ Cinch Sensitivity : 300mV
- High Level Input Sensitivity : 2.5V
- Impedance High Level : 51 Ohms
- S/N Ratio Analog-in : ≥95dB

Output

- 7 x RCA/ Cinch
- 4 x High Level Speaker Output
- 1 x Remote-out
- Voltage RCA/ Cinch : 4V RMS

Feature

- Class AB Amplifier
- Max. Output Power : 240W
- Frequency Response : 20Hz-22kHz
- Max. Current Draw : 30A
- Dimension (W x H x D) : 186 x 120 x 46mm
- Weight : 0.92 kg

Accessories



4x Tapping Screws
(4x20mm)



1x 2.0m USB Cable

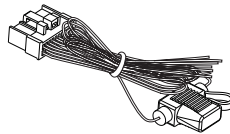

1x 30mm Universal 20P
Wiring Harness



1x Wired Remote Control
(Optional)

WIRING DIAGRAM

Car Specific Wiring Method

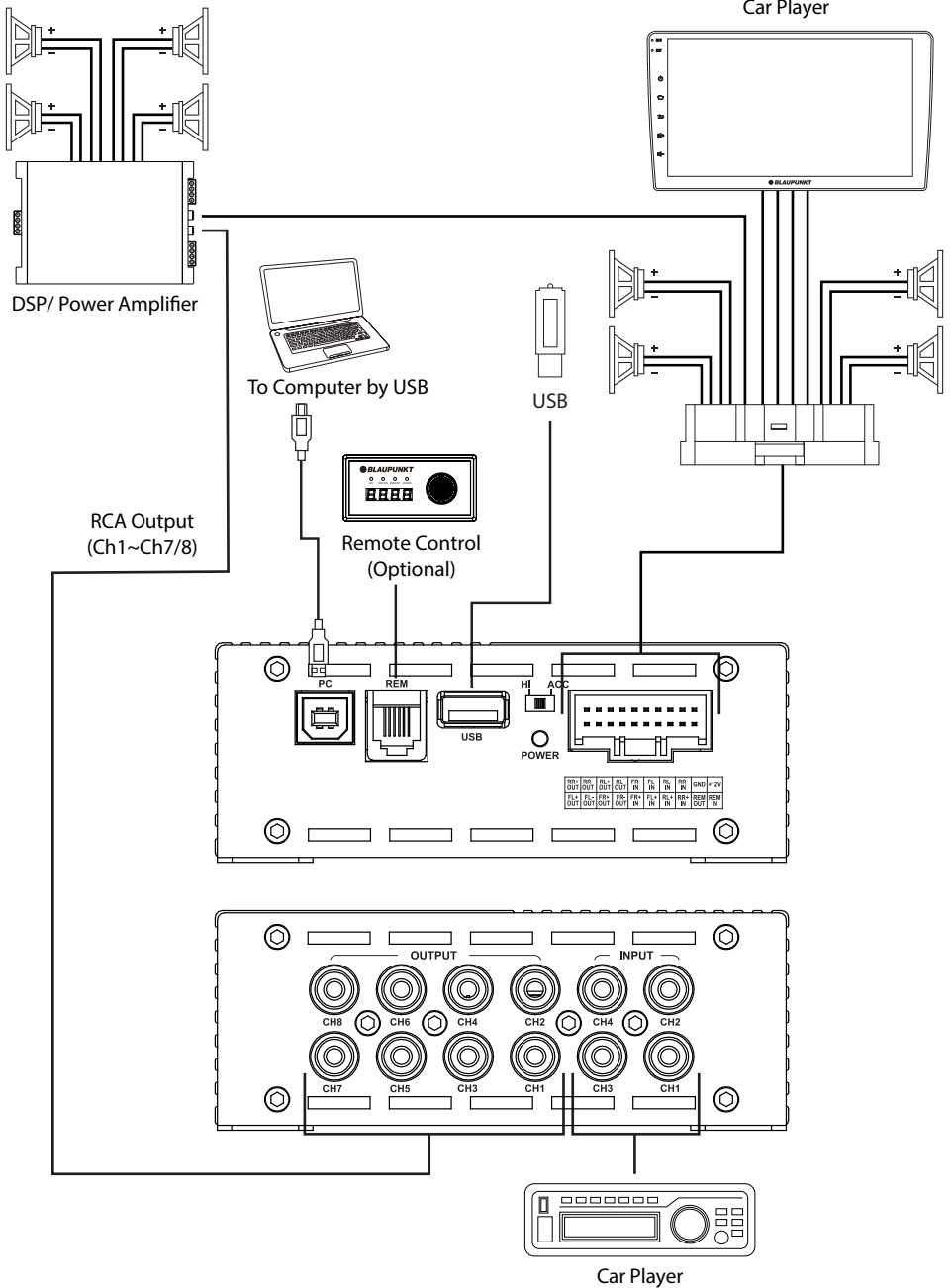

WIRING DIAGRAM

Universal Wiring Method

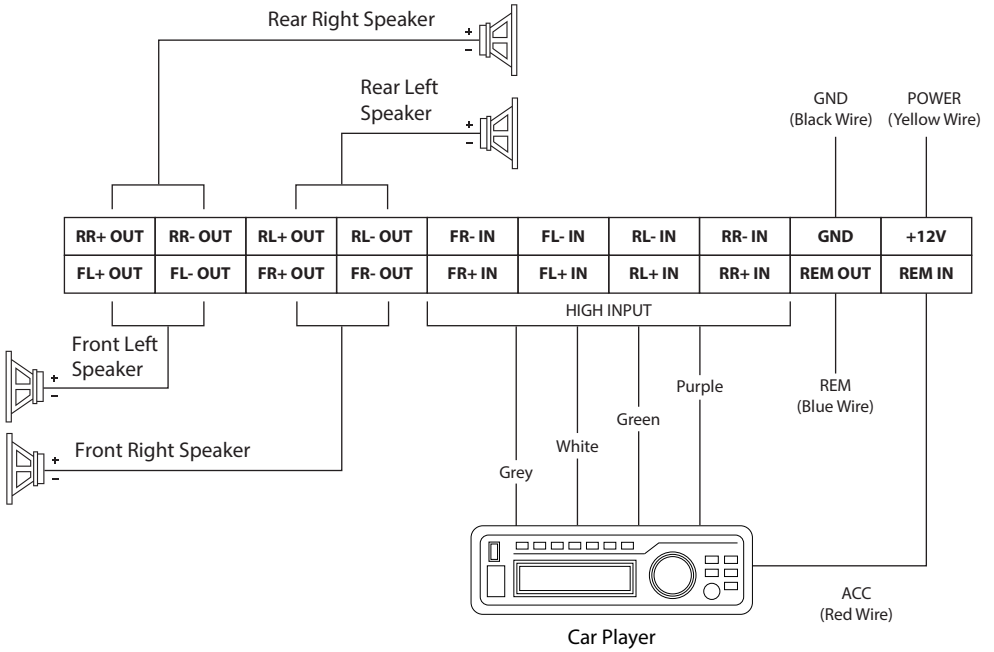

SOFTWARE OPERATION (WINDOWS)

Blaupunkt GTD 1407 A Software

Visit www.blaupunkt.com to download the software.

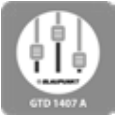

GTD 1407 A.exe

Car entertainment enthusiast / experts may now begin to tune signal details. Enhance the sound effect according to your very own preference for optimum music enjoyment with the DSP software.



Channel Panel (31-band Tuning)

1. Source Load

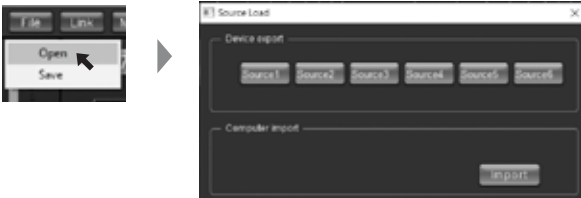

2. 7-channel Control



SOFTWARE OPERATION (WINDOWS)

3. 31-band Tuning Waveform



4. Crossover Frequency Setting :

- 3 Types of High-pass Frequency
- 3 Types of Low-pass Frequency

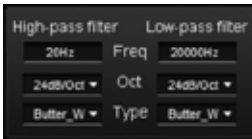

5. 31-band Equalizer Control

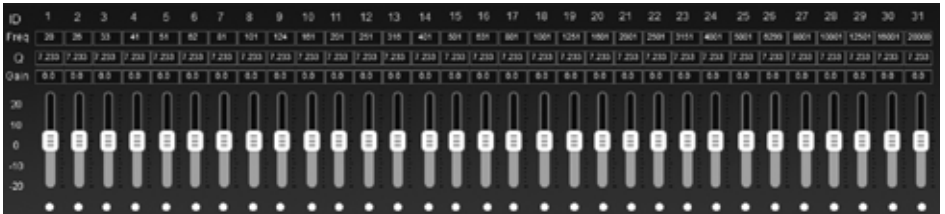

6. Main Volume Control



SOFTWARE OPERATION (MOBILE APPLICATION)

Mobile Application

- Download "Blaupunkt GTD 1407 A" App from Play Store (Android) or App Store (iOS).



Blaupunkt GTD 1407 A

Main Interface

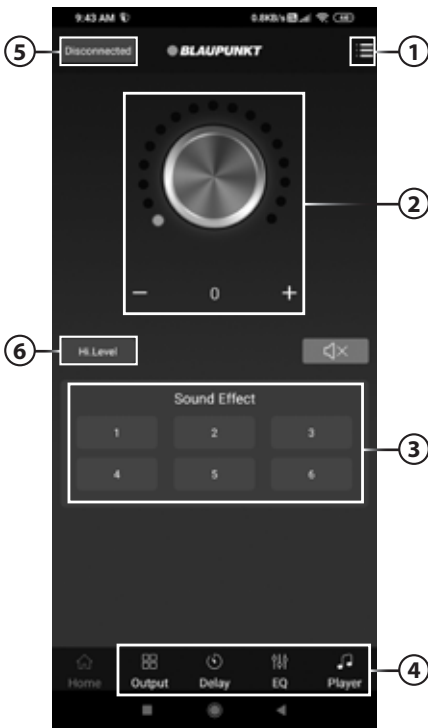

1. Setting



2. Adjustment of Main Volume

- Adjust the main volume by clicking on the scale clockwise (Increase) or counter clockwise (decrease).

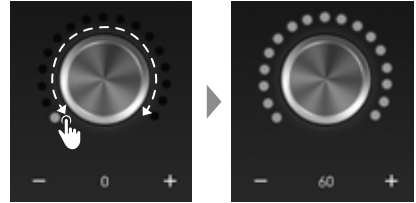

3. Sound Effect

- 6 Presets

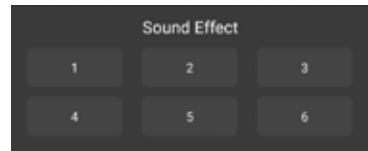

4. Bottom Navigation

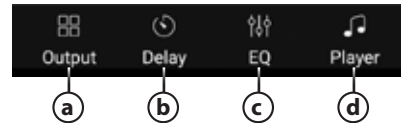

a. Output



SOFTWARE OPERATION (MOBILE APPLICATION)

b. Delay



c. EQ



d. Player

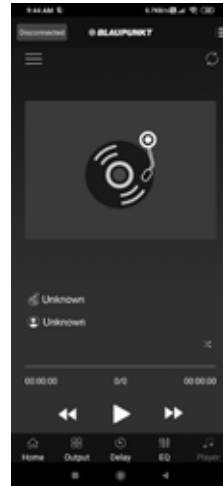

5. BT Connection

- Click on the BT icon to turn on the BT.



- Click on the available device & connect to "GTD 1407 A APP".

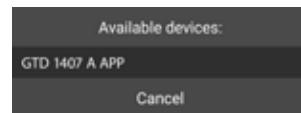

6. Input Source Setting

- Click on preferable input source.

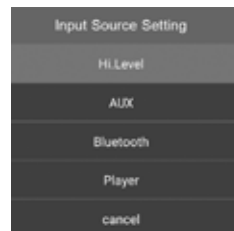

TROUBLESHOOTING

If any of the following problem occur, please resort to Troubleshooting for the possible solutions. Consult Blaupunkt authorized dealer if problem persist.

Problem	Solution
Amplifier power up failure	Examine if the ground connection is intact.
	Examine if remote input has at least 5V DC.
	Examine if battery power is connected correctly to the + terminal.
	Ensure supplied voltage is minimum 12V.
	Inspect the fuse for damage and replace it if needed.
	Restart the device if protection LED light is on.
No sound output	Examine fuses and replace if necessary.
	Examine if ground connection is intact.
	Examine if remote input has at least 5V DC.
	Examine if RCA audio cables are connected to the right inputs.
	Examine if speaker wiring is intact.
Low sound output	Reset Level Control
	Examine the Crossover Control setting.
Buzzing noise	Check if the device continues to produce noise after toggling the amplifier on and off. If yes, examine if the cables are correctly connected and if the cables and radio are in good condition.
	Repair or replace if the cables or the radio are not in good condition.
Squealing noise interference	Ensure RCA connections are properly connected.
Distorted sound output	Ensure input level of the device matches the signal level of the head unit.
	Always set the input level to the lowest.
	Examine if crossover frequency is set correctly.
	Examine if speaker wire had short-circuit.
Amplifier temperature increased	Examine if the minimum speaker impedance for the amp models is correct.
	Ensure good air ventilation around the device. Add external cooling fan if necessary.
Engine noise (static sound) interference	Typically, poor RCA cable quality is the cause of noise release.
Engine noise (alternator whine) interference	Examine if RCA cable are nowhere near or attached to the vehicle chassis. Examine if head unit is properly connected to the wires.

