



MULTIMEDIA PLAYER  
**Raleigh 910**



*Enjoy it.*

Operating instructions



- ① Microphone input
- ② Reset button
- ③ Power on/off, or mute
- ④ Return to main screen
- ⑤ Activate voice control
- ⑥ Volume+
- ⑦ Volume-

## **CONTENT**

---

<b>SAFETY INFORMATION .....</b>	<b>4</b>
<b>INSTALLATION.....</b>	<b>5</b>
<b>WIRING CONNECTION .....</b>	<b>6</b>
<b>MAIN SCREEN .....</b>	<b>7-8</b>
<b>RADIO OPERATION.....</b>	<b>9-10</b>
<b>USB MEDIA PLAYER OPERATION.....</b>	<b>11-13</b>
<b>BLUETOOTH MODE OPERATION.....</b>	<b>14-16</b>
<b>APPLE CARPLAY OPERATION .....</b>	<b>17-18</b>
<b>ANDROID AUTO OPERATION.....</b>	<b>19</b>
<b>CAMERA OPERATION.....</b>	<b>19</b>
<b>EXTERNAL MONITOR OPERATION .....</b>	<b>19-20</b>
<b>SETTINGS OPERATION .....</b>	<b>21-27</b>
<b>COMMON PROBLEMS AND SOLUTIONS .....</b>	<b>28</b>

## SAFETY INFORMATION

---

### Use This Product Safely

This set has been designed and manufactured to assure personal safety. Improper use can result in electric shock or fire hazard. The safeguards incorporated in this unit protect you if you observe the following procedures for installation, use and servicing. This unit doesn't contain any parts that can be repaired by the user.

### When Driving

Keep the volume level low enough to be aware of road and traffic conditions.

### When Car Washing

Do not expose the product to water or excessive moisture. This could cause electrical shorts, fire or other damage.

### When Parked

Parking in direct sunlight can produce very high temperatures inside your vehicle. Give the interior a chance to cool down before starting playback.

### Use the Proper Power Supply

This product is designed to operate with a 12 volt DC

### Use Authorized Service Centers

Do not attempt to disassemble or adjust this precision product. Please refer to the Service Center list included with this product for service assistance.

### For Installation

The unit should be installed in a horizontal position with the front end up at a convenient angle, but not more than 30°.

### Notes:

- Choose the mounting location where the unit will not interfere with the normal driving function of the driver.
- Before finally installing the unit, connect the wiring temporarily and make sure it is all connected up properly and the unit and the system work properly.
- Use only the parts included with the unit to ensure proper installation. The use of unauthorized parts can cause malfunctions.
- Consult with your nearest dealer if installation requires the drilling of holes or other modifications of the vehicle.
- Install the unit where it does not get in the driver's way and cannot injure the passenger if there is an emergency stop.
- If installation angle exceeds 30° from horizontal, the unit might not give its optimum performance.

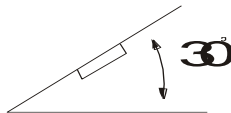

- Avoid installing the unit where it would be subject to high temperature, such as from direct sunlight, or from hot air, from the heater, or where it would be subject to dust, dirt or excessive vibration.

# INSTALLATION

---

## ***DIN FRONT/REAR-MOUNT***

This unit can be properly installed either from “Front” (conventional DIN Front-mount) or “Rear” (DIN Rear-mount installation, utilizing threaded screw holes at the sides of the unit chassis). For details, refer to the following illustrated installation methods.

### **Installation Opening**

This unit can be installed in any dashboard having an opening as shown below:

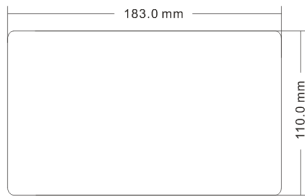

### **ATTENTIONS OF INSTALLATION**

1. This player should be installed by professional technician.
2. please read the instruction and operation of equipment carefully before installing.
3. Make sure to connect other wires before power connection.
4. To avoid short circuit. Please make sure all the exposed wire are insulating.
5. Please fix all the wires after installation.
6. Please make connection to the player accordingly to this instruction manual. Wrong connection may cause damage.
7. This player only fit for 12V DC device and please make sure your car belongs to this kind of cathode grounding electrical system.
8. Please connect the wires rightly. Wrong connection will cause malfunction or damage the electrical system.

### **Note:**

After the installation is complete, you need to set the language and radio area for the first startup:



At first, the user can touch to select the desired language, and then enter the interface for selecting the radio region. After touching the desired radio region, the user can touch the

[  ] to complete the initial setting.

## WIRING CONNECTON

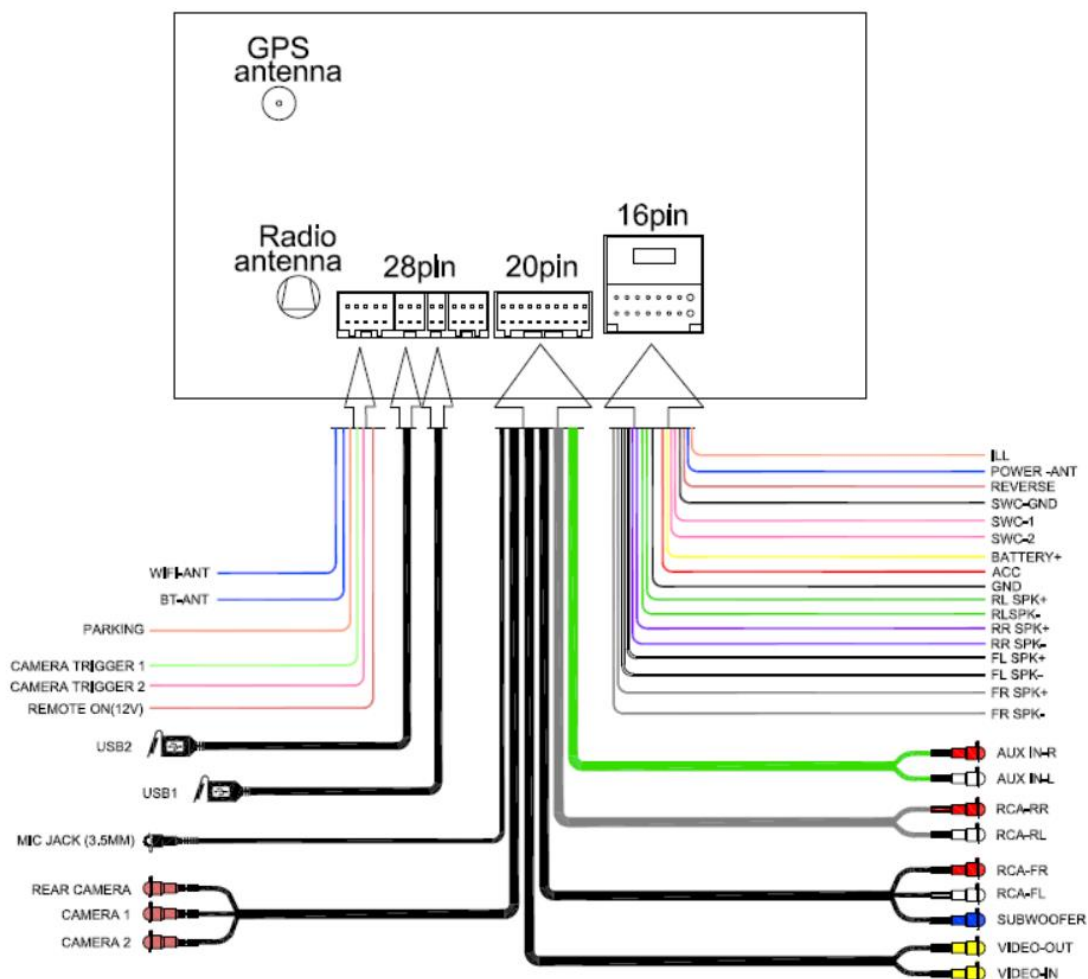



### Attention:

1. Please make sure "Battery +" and "ACC" pin location are correct before making connection
2. "Parking" wire must be connected to "ground" in order to active the video function
3. This player can only be used by the 12V DC cathode grounding electrical system.
4. Don't connect the terminals of the car battery until the player is absolutely with well erection joint.
5. Please make sure to connect the yellow wire to the positive of the battery (+).
6. When change the fuse. Please make sure the specifications are same.
7. Using good quality speaker with 4-8 ohm can result in the best effect of the equipment.
8. Connect iPhone to product via USB1 port, User can also go to Apple CarPlay. or connect Android Auto compatible phone to product via USB1 port.

## Main screen

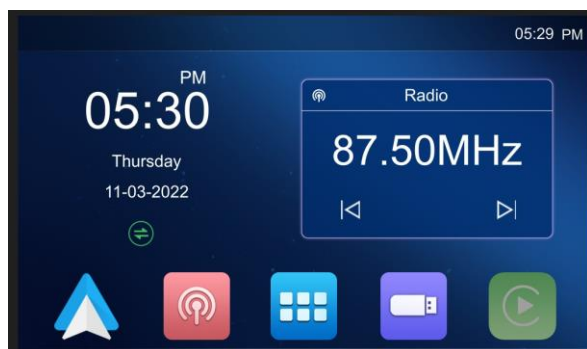
---



Touch [  ] to enter device menu, the following menu appears:

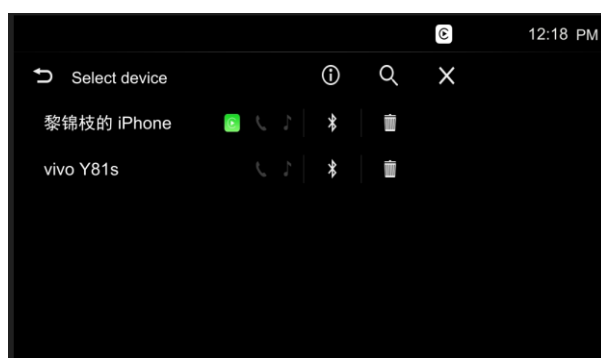

Touch [  ] to show between the driver name and the driver address

Touch [  ] to connect CarPlay.

Touch [  ] to connect Bluetooth.

Touch [  ] to delete the device.

Touch [  ] to Search devices.

Touch [  ] or [  ] to exit device menu.

Touch [  ] icon to enter home menu.



## Home menu

---

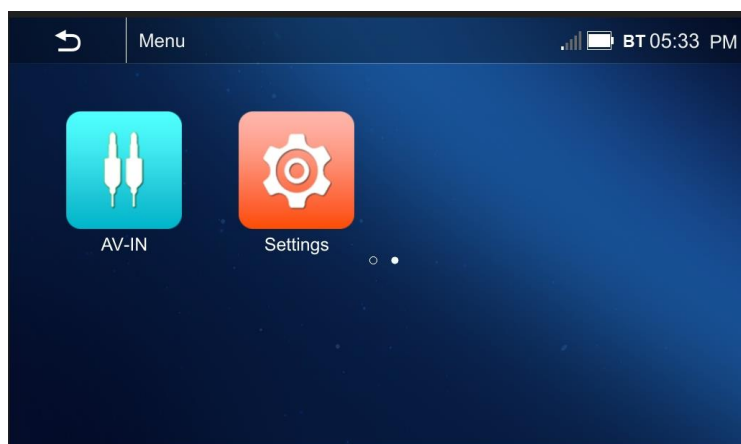

Android Auto:	Connect to Android phone
Radio:	Listen to FM or AM radio program
Phone:	Make a hands-free phone call
USB:	Play music/video/image in USB device
Apple CarPlay:	Connect to iPhone
BT Music:	Play audio streaming through Bluetooth
Camera 1:	View left or right camera
Camera 2:	View left or right camera
AV-IN:	External audio/video players
Settings:	Set the parameters of the product



## OPERATION

### Radio mode

In the main menu, press the [Radio] icon. The radio page menu is displayed.



### Select FM / AM band

Up to 30 stations can be stored under the FM band and AM band.



☞ Touch the [  ] to change FM1/FM2/FM3/AM1/AM2 band.

### Tuning into a station

#### Tuning into stations manually

☞ Long press the [  ] or [  ] to search previous or next by step.

#### Station seek tuning

☞ Touch the [  ] or [  ] to search for the previous or next available radio station. If the station is searched, the process will stop and play the station searched.

## OPERATION

---

### Storing stations manually

- ☛ Touch [  ] to select FM1/FM2/FM3/AM1/AM2 band.
- ☛ Received the desired station.
- ☛ Press one of the memory buttons [1]-[6] for approx. 2 seconds to store the current station at the button. The station is stored.

### Automatic Search and Storage Station

- ☛ Long press [  ] to automatic search and save station; When search is completed, the first radio station searched will be automatically played and the stations will stored in the preset [ 1 ] ~FM3(or AM1/AM2).

### Scanning stations

- ☛ Touch the [  ] to listen the preset stations [1] to [6] FM1~FM3(or AM1/AM2) for few seconds.

### Directly enter frequency

- ☛ Press [  ] button then input desired station frequency and press [ OK ] button.

### Adjusting the seek tuning sensitivity

The seek tuning sensitivity decides whether the automatic station seek tuning finds only strong stations or also weaker stations that may be noisy.

- ☛ Touch [  ] to adjust the sensitivity of station seek tuning.
  - If **LOC** is displayed, only stations with a strong signal are found during seek tuning.
  - If **DX** is displayed, stations with a strong and weak signal are found during seek tuning.

### RDS function

Many FM stations broadcast an RDS (Radio Data System) signal in addition to their programme in the Europe reception area that allows additional functions, such as the display of the station name.

### Switching AF(Alternate frequencies) function on/off

If the AF function is activated, the car audio system automatically tunes into the best receivable frequency for the station that is currently set.

- ☛ Press [ AF ] button to switch the AF function on/off.
- ☛ If the AF function is switched on, AF is displayed.

### Switching the TA (Travel Announcement) function on/off

If the TA function is activated, the car audio system automatically receive travel announcement.

- ☛ Press [ TA ] button to switch the TA function on/off.

## OPERATION

☛ If the TA function is switched on, TA is displayed.

### Selecting the program type and starting seek tuning

You can select a program type with the PTY function to search for stations of a particular genre, the following PTY List.



### USB media player

Insert USB Flash Drive with media files.

Supporting Format

- Music: MP3, WMA, FLAC, WAV.
- Video: MP4, WMV, MKV, AVI, MPEG.
- Picture: JPG, PNG, BMP.

### Connecting a USB data carrier

- ☛ Insert the data carrier to the USB2 socket.
- ☛ The device automatically switches to USB mode. The data is read, and playback starts with the first media file recognized by the device.

### Play Music



## OPERATION

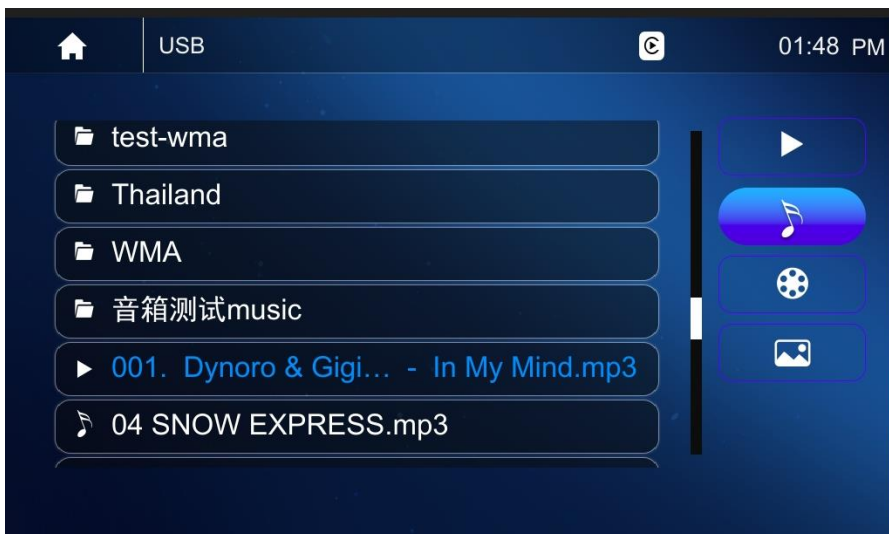
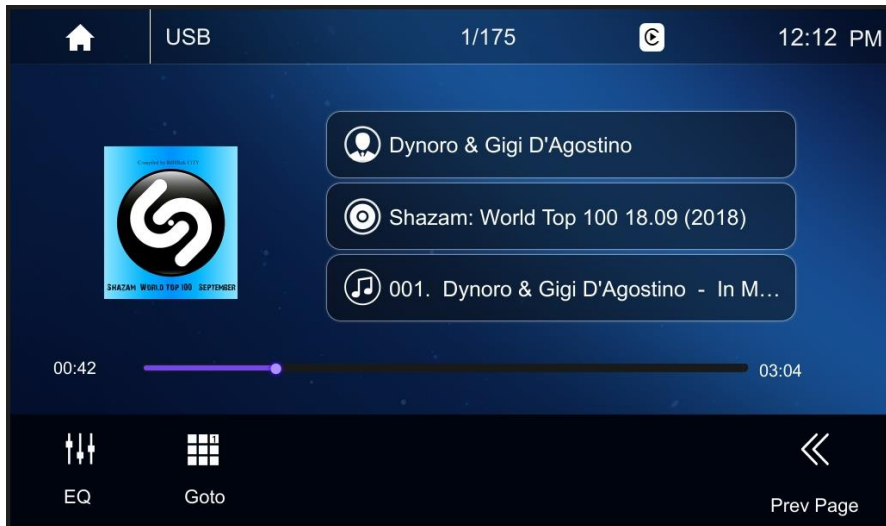

Touch [  ], Display the folder/file list.

Touch [  ] to play the next track.

Touch [  ] to play the previous track.

Touch [  ] or [  ] to pause current playing track or replay the paused track.

[  ] Repeat All files.

[  ] Repeat the same files.

[  ] Repeat all files of current folder.

[  ] Playback in random.

[  ] Display equalizer.

## OPERATION

---



[  ] Input desired track

[  ] Return to the player interface.

Drag the [  ] for fixed-point playback.

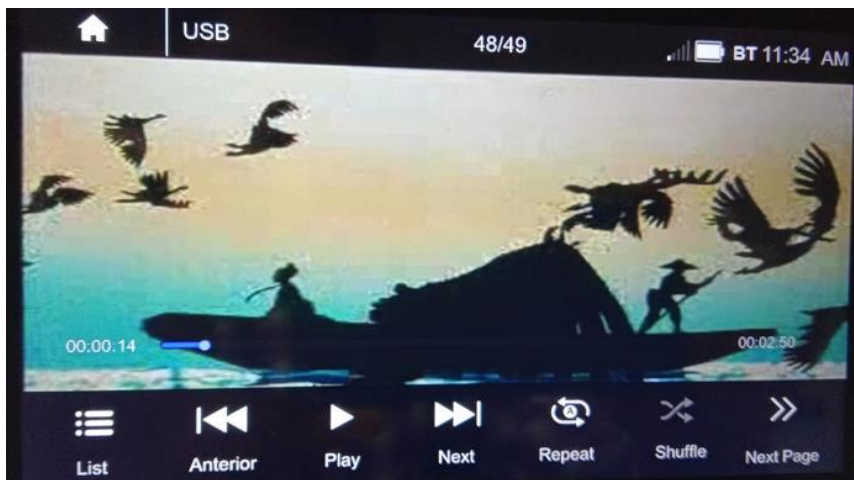
### Video playback from USB



Touch [  ], select [  ] to show the video list then select the video track to play.

Touch the screen to enter full screen mode. If current state is full screen mode, touch the screen again to exit full screen mode.

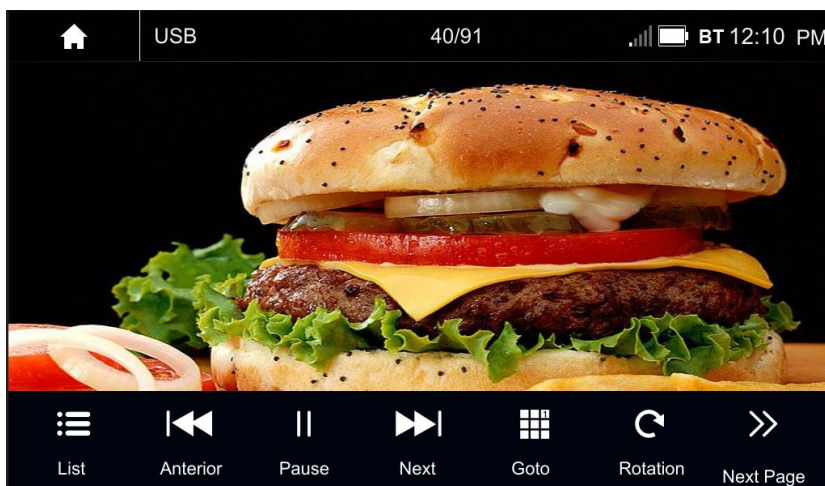

### Image playback from USB

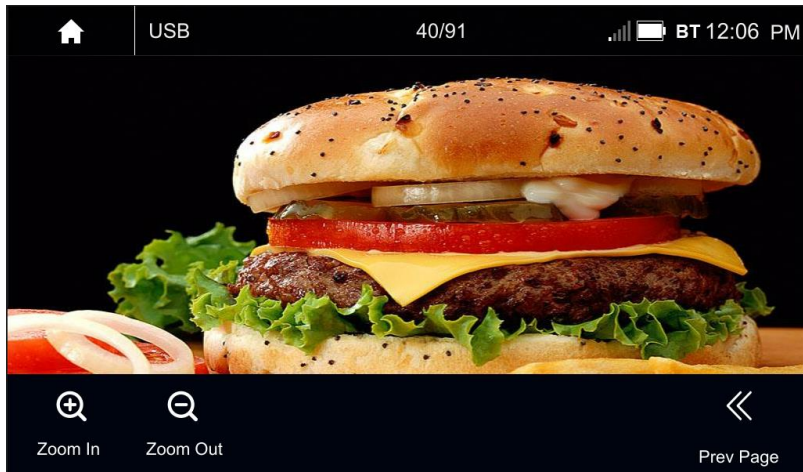

## OPERATION

---



Touch [  ], select [  ] to show the picture list then select the picture to play.

Touch [  ] to rotate current playing pictures.

Touch [  ] or [  ] to zoom in or zoom out current playing pictures.

Touch the screen to enter full screen mode. If current state is full screen mode, touch the screen again to exit full screen mode.

### **Bluetooth mode**

The Bluetooth connection is not available when Apple CarPlay is on.

The Bluetooth® function allows pairing cell phones & BT equipped media playback devices with the car audio system.

Once you pair a cell phone with the car audio system, you can make phone calls with the built-in hands free function. You can access the list of dialed numbers and the phone book of the registered cell phone after selecting “Sync” option.

If the connected Bluetooth® device supports the functions like A2DP and AVRCP, you can play music via the car audio system and control playback. During a call, music playback is interrupted and resumes again after the call.

If a cell phone is paired via Bluetooth® and a call is received during playback, the source playback is interrupted and the call menu is displayed.

### **Bluetooth pairing**

- ☛ Select the Bluetooth item and search the Bluetooth device on your phone. Select “Raleigh 910” and confirm that this code is shown on “Raleigh 910”. Do not enter this code on any accessory. The BT icon will be displayed when successful paired.

## OPERATION



### Connection status

☛ If a mobile phone/device is connected with the car audio system, the Bluetooth® icon is displayed at the top right corner of the display in all audio/video sources.

### Bluetooth PHONE mode

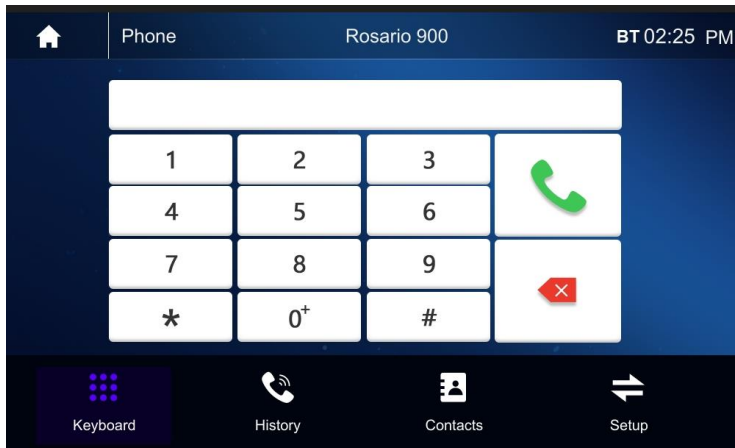
Select In the main menu, press [ Phone ], the following menu appears.



1.Touch [  ] to select the digital numbers on the dial keyboard, touch the [  ] to make a phone call.

2.Touch [  ] to enter contacts list then select a name from the phone book to call.

3.Touch [  ] to enter history record list then choose a record number for calling.

4.Touch [  Setup ] to enter Bluetooth setup, the following menu appears:

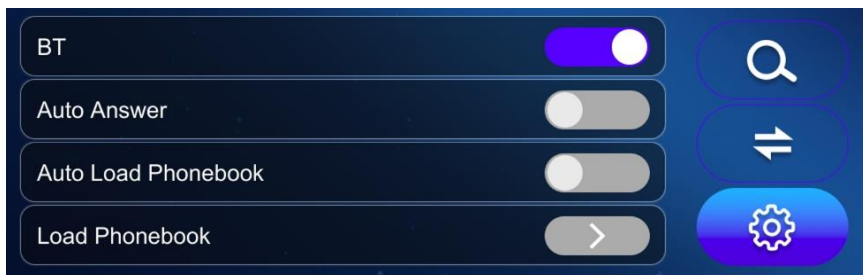

Bluetooth settings numu:

BT : on/off

Auto Answer: on/off

## OPERATION

---

Auto Load Phonebook: on/off

Load Phonebook: Touch [ > ] to loading Phonebook.

Touch [  ] to search the surrounding Bluetooth Device. Make sure Bluetooth on device is enable and discoverable;All devices searched will be displayed on the product screen.

Touch [  ] to enter the paired mobile device. the following appears:

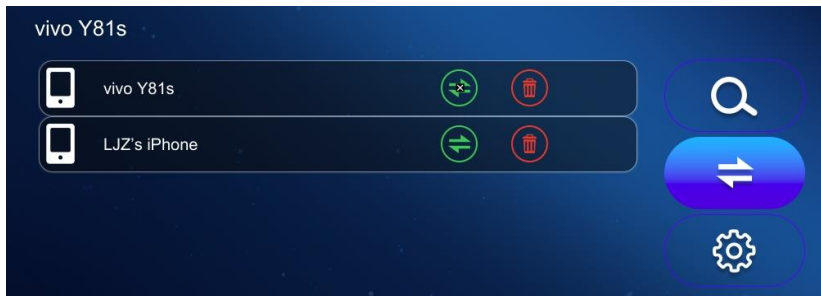



Touch the [  ] to disconnect the Bluetooth phone

Touch the [  ] to connect the Bluetooth phone.

Touch the [  ] to delete the device paired.

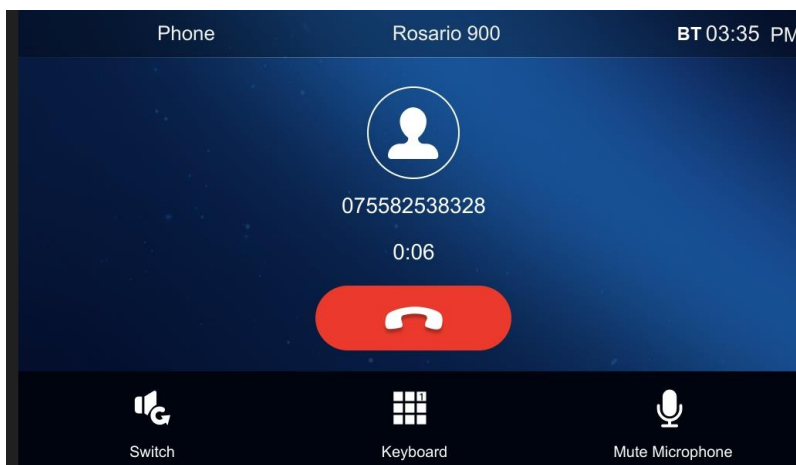
### Hands-free Mode and Private Mode



During a call, touch [  ] to switch between Hands-free mode and private mode; Touch [  ] to mute microphone so that the receiver hear from your side.



## OPERATION

---

[  ] Answer/dial out a call.

[  ] Reject/cancel a call.

### Bluetooth playback mode

Select In the main menu, press [ BT Music ], the following menu appears.

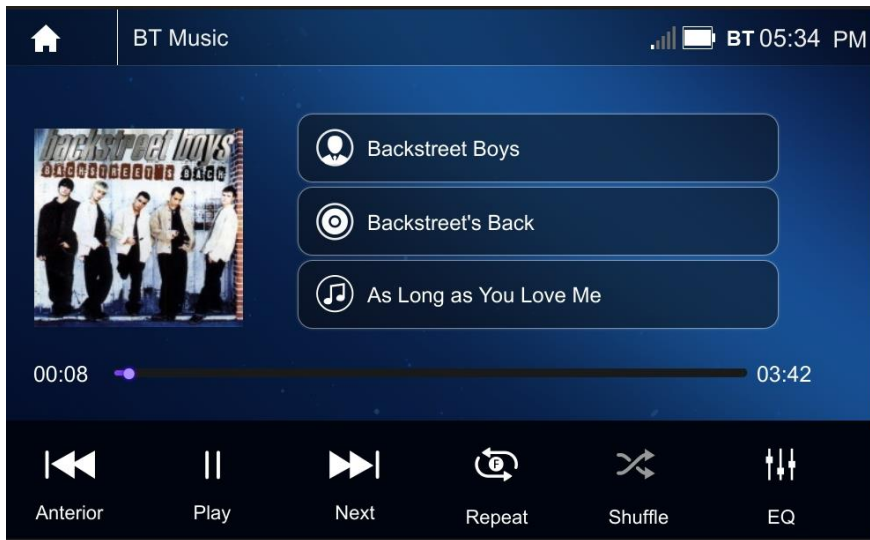

Touch [  ] to switch next track.

Touch [  ] to switch previous track.

Touch [  ] to pause playback, touch [  ] to play.

### External audio / video sources (AV-IN)

Connect an external component to the AV-IN input terminal.

Select AV-IN as the source.

Turn on the connected component and start playing the source

### Apple CarPlay (Wired and Wireless)

#### Connection

1. Connect iPhone to product USB1 port via lightning cable, the product screen will automatically show the CarPlay interface. User can operate the common functions of iPhone on the product. iPhone support : minimum iPhone5; Required iOS: minimum iOS 7.1.

## OPERATION

---

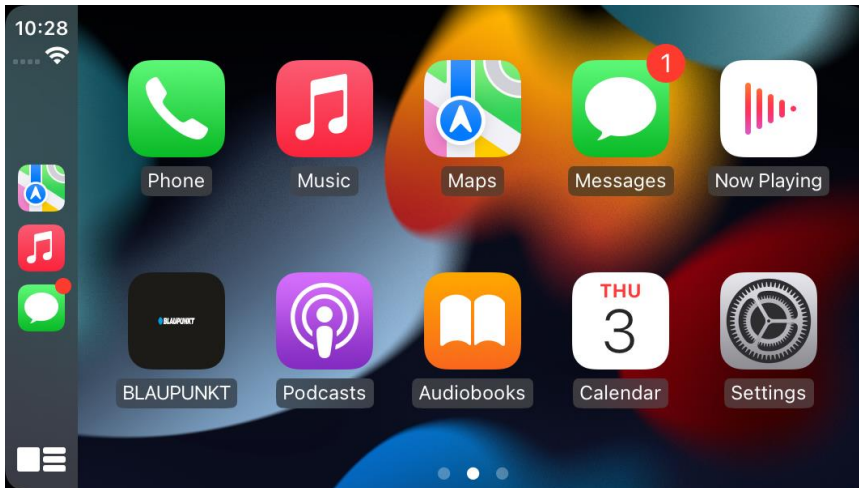

2. When connect iPhone via USB1 port, you can select " Enable Wireless CarPlay" to enable wireless CarPlay. User can also go to Select Device list and then initiate wireless connection via Bluetooth pairing.

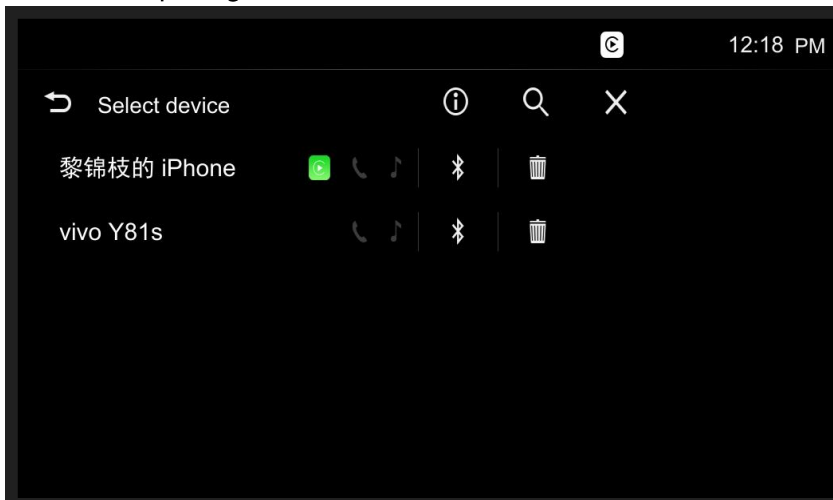

Call Out / Receive Call

Touch the phone button on the main interface of CarPlay for Calling.

Play Music

Touch the music button on the main interface of CarPlay to play all of contents from iTunes.

Use Map

Touch the navigation button on the main interface of CarPlay to show the maps.

Siri

1. Touch and hold Apple Home key on the iPhone device for using Siri voice assistant, such as making a call, playing music, opening the map and other voice commands;
2. Touch the voice key [  ] on the front panel;
3. When iPhone is connected, enable Siri by steering wheel (some cars);
4. Control with " Hey, Siri".

# OPERATION

---

## Android Auto (Wired and Wireless)

1. Connect Android Auto compatible phone to product USB1 port via standard USB cable. Drivers can enjoy music from their phone, show the way with Google map or other map App and make or receive a call. User need to enable Bluetooth on both phones and the product at the same time. Required Android OS:6.0.  
(Android Auto App must be installed on the phone before connecting)
2. User can also go to Select Device list and then initiate wireless connection via Bluetooth pairing.

## Camera 1 Input

This device features a video input at the rear of the device for connecting a left or right view camera that is available as an option (sold separately). If a left or right view camera is connected, the image is displayed on the screen, when select camera 1 as the source.

- 🔑 When connect CAM 1 trigger wire to left or right lamp power supply can to view camera 1

## Camera 2 Input

This device features a video input at the rear of the device for connecting a left or right view camera that is available as an option (sold separately). If a left or right view camera is connected, the image is displayed on the screen, when select camera 2 as the source.

- 🔑 When connect CAM 2 trigger wire to left or right lamp power supply can to view camera 2

## Rear Camera Input

This device features a video input at the rear of the device for connecting a rear view camera that is available as an option (sold separately). If a rear view camera is connected, the image is displayed on the screen, when the reverse gear is engaged.

- 🔑 Connect REVERSE wire to reverse lamp power supply to detect when the reverse gear is engaged.

## External monitor

This device features a video out for connecting an external monitor for passengers in the rear seat (see Connection diagram at the end of these instructions).

- 🔑 Select the desired source via the main menu and start movie playback, e.g. from a USB. The image is displayed on the rear monitor.

# OPERATION

---

## Settings

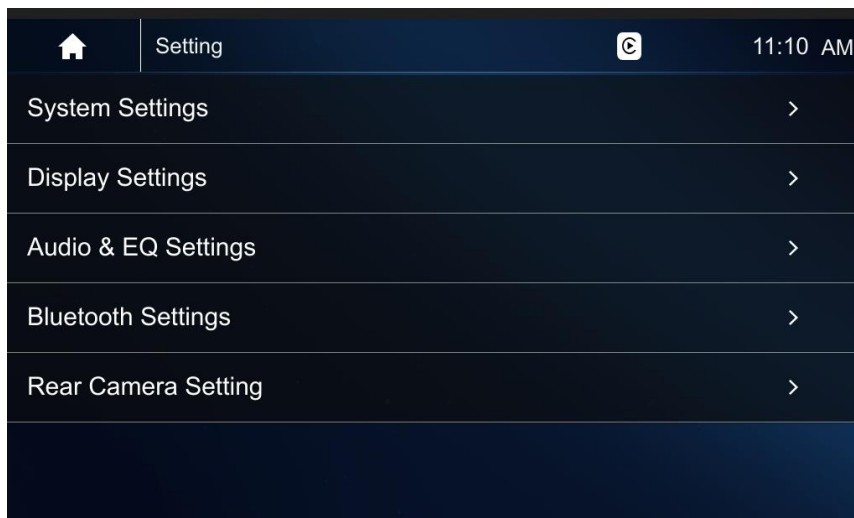

## System Settings

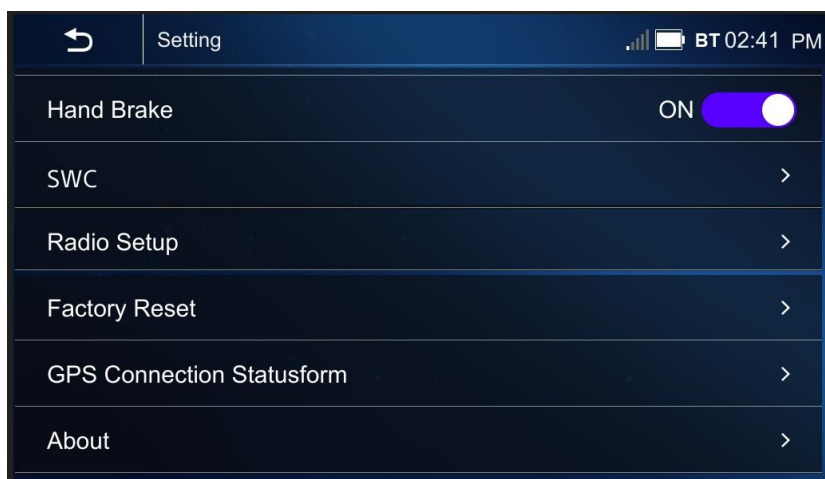
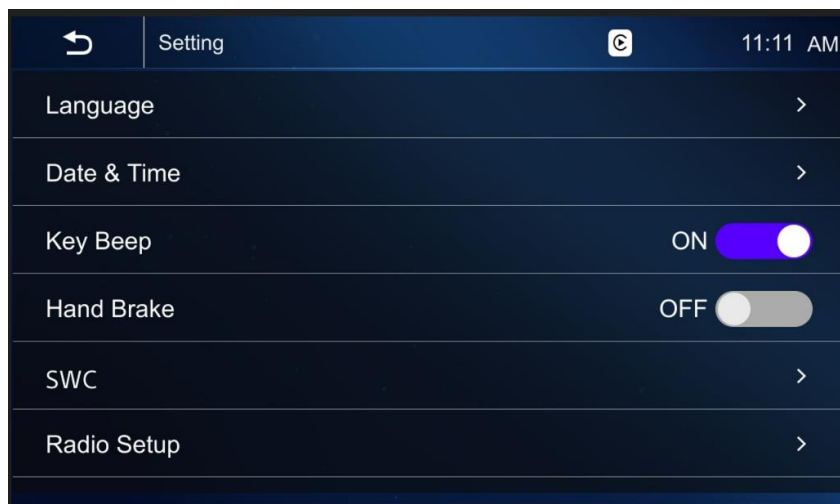

## OPERATION

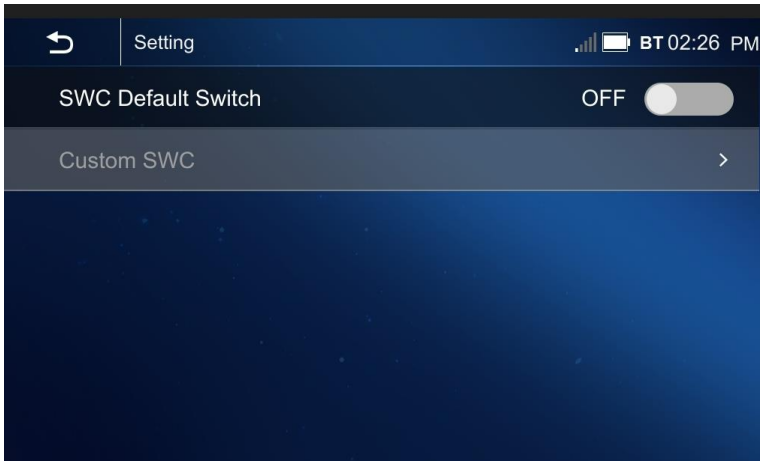

---

1. Touch to select language;
2. Touch to select date & time
3. Open/Close key beep
4. Open/Close hand brack
5. Touch to select SWC, the following menu appears.



Open/Close SWC default switch, When user open SWC default switch, touch to select custom SWC



After the [  ] is touched, select the keys you wanted to set. Long press one steering wheel key to complete the function setting. One by one by pressing the steering wheel above key, and records the order, click on the corresponding function settings ,touch [  ] to save settings.

6. Touch to select radio setup. Open/Close RDS; touch to select the region.
7. Touch to select factory reset, All the memories will be lost!
8. Touch to select GPS Connection Statusform, View GPS position status.
9. Touch to select About. View the current software version.

# OPERATION

---

## Display Settings

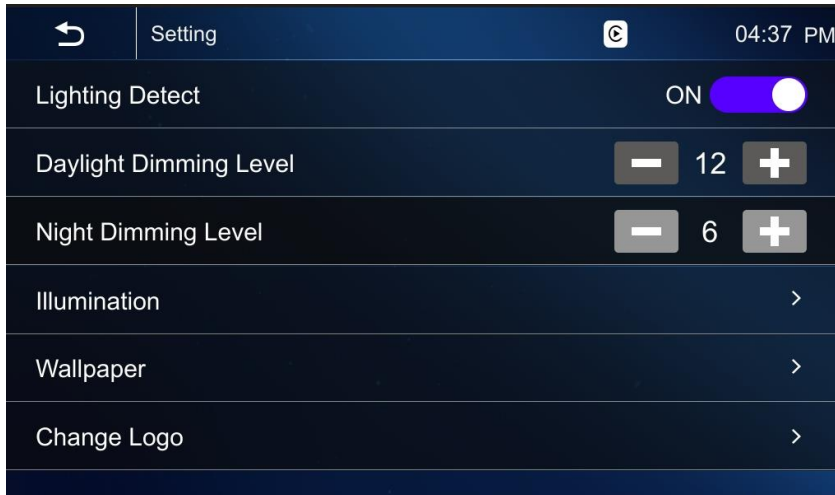

Open/Close Lighting Detect

Adjust daylight dimming level or night dimming level, when lighting detect is on, adjust night dimming level.

Illumination settings, the following menu appears.

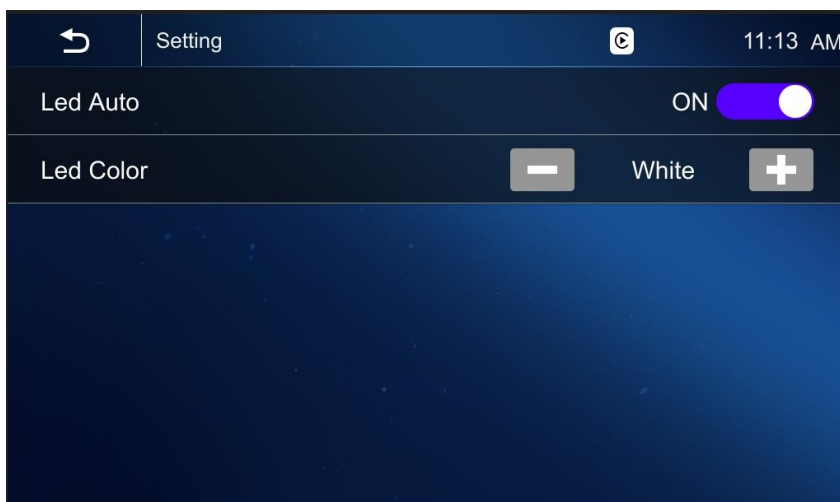

Open/Close Led Auto. When Auto Led is on, backlit keys in automatic cycle display White/Red/Yellow/Blue/Green/Purple/Light Green, when the Led Auto is off, you can choose single color backlighting.

Touch to enter wallpaper interface, you can select your favorite wallpaper in the background.

## OPERATION

---

Touch to enter change logo interface. the following menu appears.

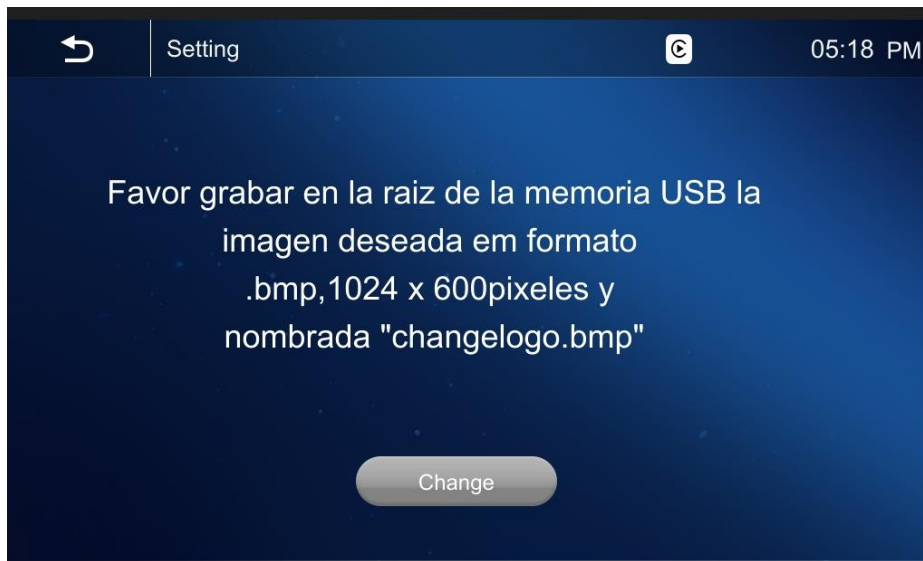

you can change start screen logo, follow the steps below:

BMP name is set to 1024 x 600 in the root directory of the USB flash drive.

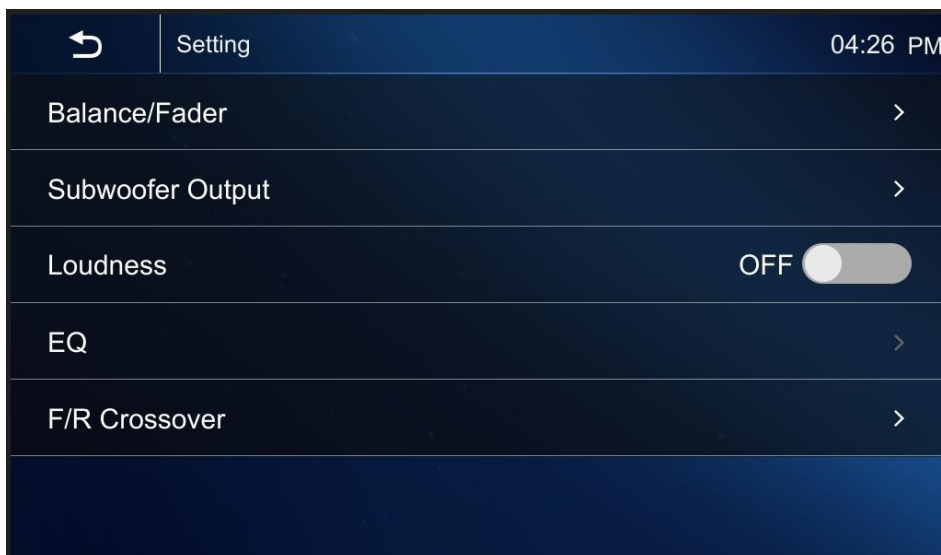

### Audio & EQ Settings

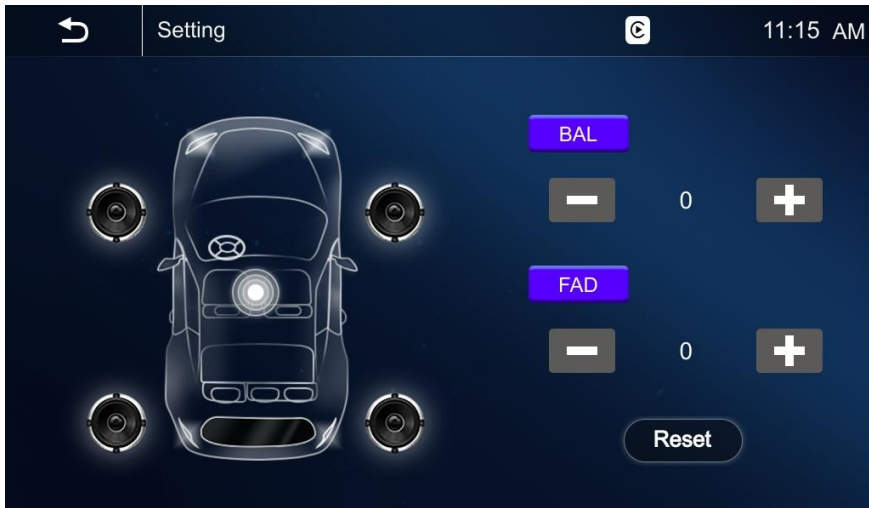

1. Adjust Balance/Fader, the following menu appears.

## OPERATION







Touch [  ] or [  ] to adjust fader & balance, touch [  ] to reset fader and balance.

2. Touch to enter Subwoofer Output interface, the following menu appears.



Open/Close subwoofer output.

Touch [  ] or [  ] to adjust subwoofer level 0 to +10.

Touch [  ] or [  ] to adjust subwoofer phase 0° to 180°.



## OPERATION

---

Touch to enter subwoofer crossovers interface, the following menu appears.



Low Pass Filter adjustment. Use – and + to select frequency 60Hz, 80Hz, 100Hz,120Hz,160Hz and 200Hz

Use – and + to set a crossover slope 12dB or 24dB.

3. Open/Close Loudness effect.
4. EQ Settings, the following menu appears.

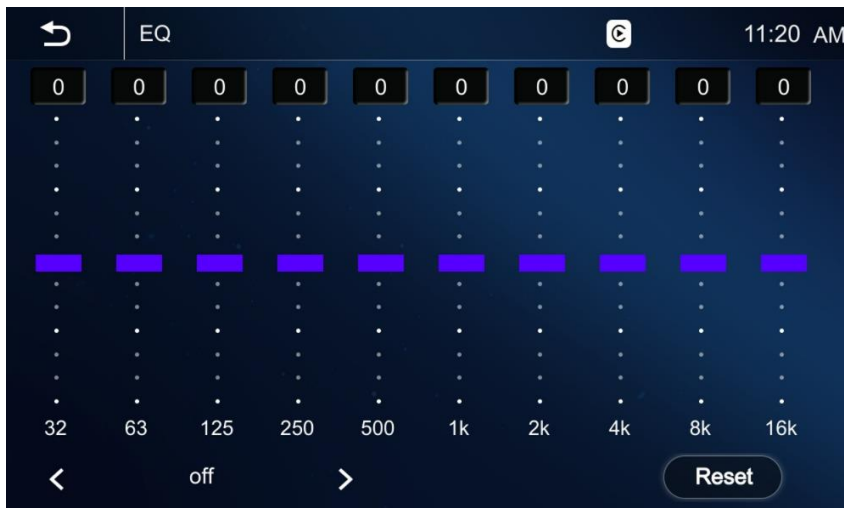

Select a preset equalizer via < or >

Select EQ Custom to set the levels of the available frequency bands according to your preferences.

You can adjust the equalizer for all sources. Touch the [  ] to enter the equalizer menu.

**Note:**

Touch the [ Reset ] to reset the customized setting again

## OPERATION

---

5. Front and Rear Crossover, the following menu appears.

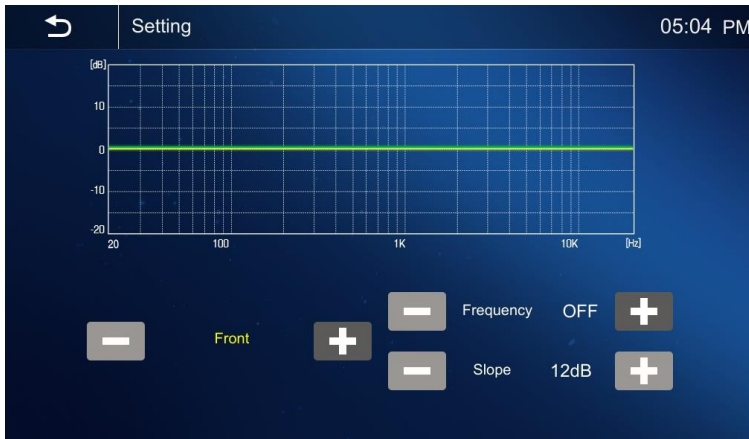

Use – and + to select front or rear

Use – and + to select frequency off, with all pass.

High Pass Filter adjustment. Use – and + to select frequency 60Hz, 80Hz, 100Hz, 125Hz.

Use – and + to set a crossover slope 12dB or 24dB.

6. Mic Select internal or external, When Internal is selected, the internal microphone is effective, and when External is selected, the external microphone is effective

### Bluetooth Settings

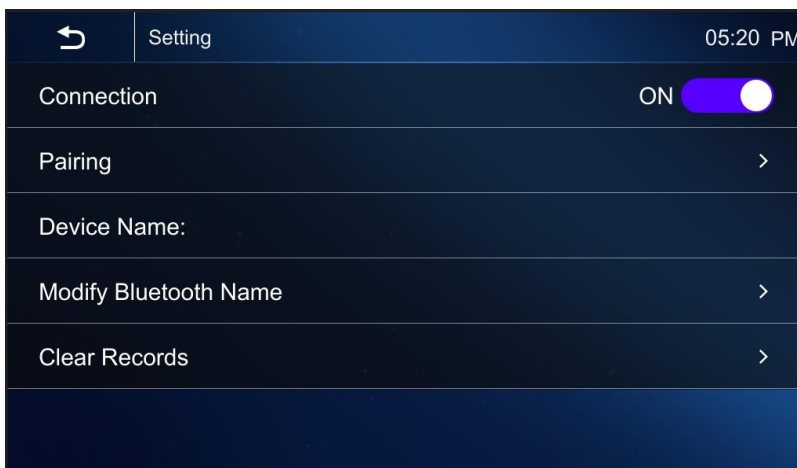

1. Open/Close Bluetooth connection.
2. Pairing mode from Bluetooth device connection.
3. Displays the device name of the Bluetooth connected device
4. Users can modify the Bluetooth name
5. The user can clear connected or paired devices

## OPERATION

---

### Rear Camera Setting

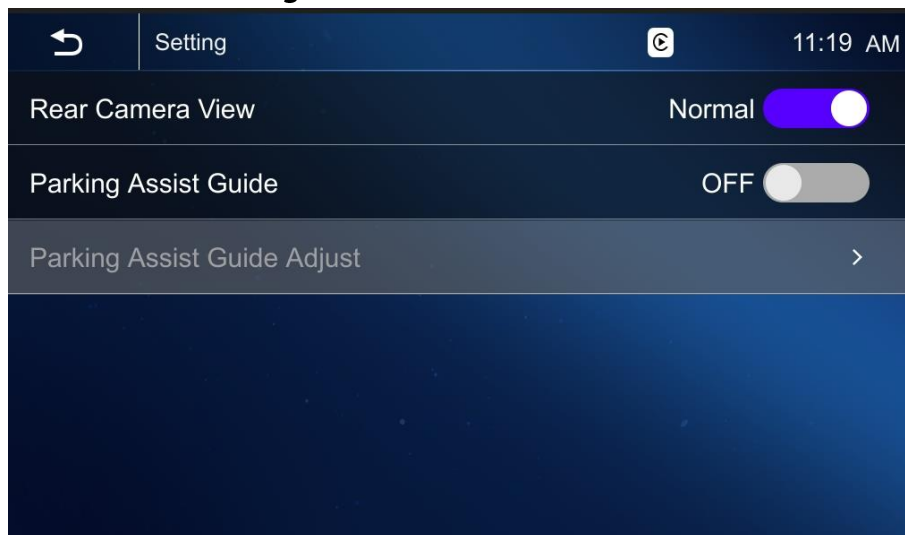

1. When the rear camera View is set to normal, the video is in normal View. When the rear camera View is set to reverse, the video is in reverse View.
2. Open/Close parking assist guide. When the parking assist guide is set on, the Parking assist guide view is displayed
3. Users can adjust the parking assist guide. (Only the parking assist guide is set on.)

## COMMON PROBLEMS AND SOLUTIONS

---

When there is a problem with the machine

1. Recovery to factory settings or reset;
2. Try reigniting;
3. Please check the phenomena that described in the table below and try to use the solutions;
4. Contact Service Center;

Machine/function	Phenomena	Solutions
Machine	Cannot power on/off	Check the connection, if it is broken, try to reconnect it; Check the main fuse, if it is damaged, replace it; Press reset key
	No sound	Adjust the volume; Confirm whether the music and video is supported or not; confirm whether the connection of the power amplifier is lost;
Reversing	Abnormal picture	Exit reversing mode and enter again; Check whether the camera is covered by foreign matters; Check whether the type of reverse camera is matched or not; Check the reversing signal cable;
Radio	Noisy; Con not search the station	Ensure there is no metal products around the machine; Driving the vehicle to the place where the radio signal is good and search the station; If the solutions above are invalid, please check whether the antenna is disconnected, damaged, etc.;
Bluetooth	Connecting fail	Please make sure that the Bluetooth of mobile device is turned on, the machine is not connected;
USB playing	Playing fail	Ensure the U disk is not damaged; Please make sure that the format of content is supported;

**FOR MORE LANGUAGES, PLEASE SCAN QR CODE BELOW:**

**PARA MÁS IDIOMAS, FAVOR ESCANEAR EL CÓDIGO QR  
ABAJO:**

**POUR PLUS DE LANGUES, VEUILLEZ SCANNER LE CODE  
QR CI-DESSOUS :**



BP Americas Corp.  
Doral, Florida 33178 USA  
[www.bpcarusa.com](http://www.bpcarusa.com)

BP Americas Paraguay S.A.  
Asunción, Paraguay  
[info@bpamericas.com](mailto:info@bpamericas.com)